



SAM E54 Xplained Pro

SAM E54 Xplained Pro User's Guide

Preface

The SAM E54 Xplained Pro evaluation kit is a hardware platform to evaluate the ATSAME54P20A microcontroller.

Supported by the integrated development platform Atmel Studio, the kit provides easy access to the features of the ATSAME54P20A and explains how to integrate the device in a custom design.

The Xplained Pro MCU series evaluation kits include an on-board Embedded Debugger, and no external tools are necessary to program or debug the ATSAME54P20A.

The Xplained Pro extension kits offers additional peripherals to extend the features of the board and ease the development of custom designs.

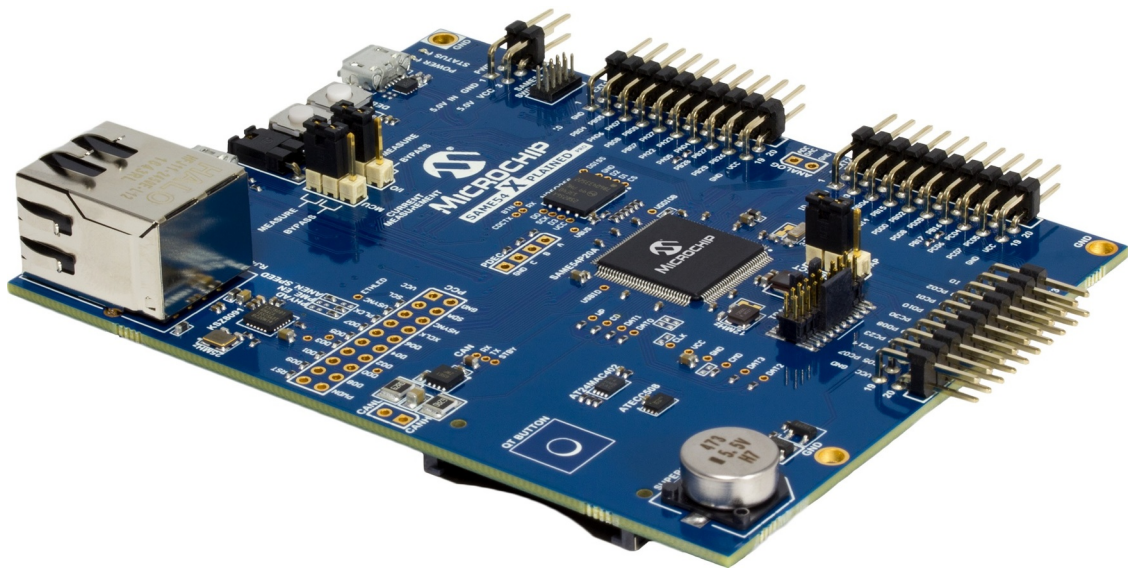

Table of Contents

Preface.....	1
1. Object of Declaration.....	4
2. Introduction.....	5
2.1. Features.....	5
2.2. Kit Overview.....	6
3. Getting Started.....	7
3.1. Xplained Pro Quick Start.....	7
3.2. Design Documentation and Relevant Links.....	7
4. Xplained Pro.....	9
4.1. Embedded Debugger.....	9
4.2. Xplained Pro Analog Module (XAM).....	10
4.2.1. Overview.....	10
4.2.2. EDBG Interface.....	11
4.2.3. Sample Rate.....	11
4.2.4. Measurement Ranges and Accuracy.....	11
4.3. Hardware Identification System.....	12
4.4. Power Sources.....	12
4.5. Xplained Pro Headers and Connectors.....	13
4.5.1. Xplained Pro Standard Extension Header.....	13
4.5.2. Xplained Pro Power Header.....	14
5. Hardware User Guide.....	15
5.1. Power Distribution.....	15
5.2. Connectors.....	15
5.2.1. Xplained Pro Standard Extension Headers.....	16
5.2.2. SD/SDIO Card.....	19
5.2.3. PCC Camera Connector.....	19
5.2.4. Position Decoder.....	21
5.2.5. VBAT Backup Select.....	21
5.2.6. ADC/DAC Header.....	21
5.2.7. USB.....	21
5.2.8. Cortex Debug Connector.....	22
5.2.9. Cortex Debug Connector with Trace.....	22
5.2.10. Current Measurement Header.....	23
5.3. Peripherals.....	24
5.3.1. Crystals.....	24
5.3.2. Mechanical Buttons.....	24
5.3.3. LED.....	25
5.3.4. QTouch Button.....	25
5.3.5. Backup Super Capacitor.....	25
5.3.6. CAN.....	26

5.3.7.	Ethernet.....	26
5.3.8.	AT24MAC402.....	27
5.3.9.	ATECC508A.....	28
5.3.10.	QSPI Flash.....	28
5.3.11.	I ² S Signals.....	29
5.4.	Embedded Debugger Implementation.....	30
5.4.1.	Serial Wire Debug.....	30
5.4.2.	Virtual COM Port.....	30
5.4.3.	Data Gateway Interface.....	30
5.4.4.	XAM Configuration.....	31
5.5.	Kit Modifications.....	32
5.5.1.	Enable PCC Header.....	36
5.5.2.	Operation at Other Voltages.....	37
5.6.	Low-Power Mode.....	38
6.	Kit Specific Data.....	39
7.	Appendix.....	40
7.1.	Getting Started with IAR.....	40
7.2.	Connecting External Debuggers to an Xplained Pro Board.....	43
8.	Hardware Revision History and Known Issues.....	45
8.1.	Identifying Product ID and Revision.....	45
8.2.	Revision 5.....	45
8.2.1.	VBAT Pin.....	45
8.3.	Revision 4.....	45
8.3.1.	VBAT Pin.....	45
8.3.2.	32.768 KHz Crystal.....	46
9.	Document Revision History.....	47
	The Microchip Web Site.....	48
	Customer Change Notification Service.....	48
	Customer Support.....	48
	Microchip Devices Code Protection Feature.....	48
	Legal Notice.....	49
	Trademarks.....	49
	Quality Management System Certified by DNV.....	50
	Worldwide Sales and Service.....	51

1. Object of Declaration

EU Declaration of Conformity for SAM E54 Xplained Pro

This declaration of conformity is issued by the manufacturer.

The development/evaluation tool is designed to be used for research and development in a laboratory environment. This development/evaluation tool is not a Finished Appliance, nor is it intended for incorporation into Finished Appliances that are made commercially available as single functional units to end users under EU EMC Directive 2004/108/EC and as supported by the European Commission's Guide for the EMC Directive 2004/108/EC (8th February 2010).

This development/evaluation tool complies with EU RoHS2 Directive 2011/65/EU.

This development/evaluation tool, when incorporating wireless and radio-telecom functionality, is in compliance with the essential requirement and other relevant provisions of the R&TTE Directive 1999/5/EC and the FCC rules as stated in the declaration of conformity provided in the module datasheet and the module product page available at www.microchip.com.

For information regarding the exclusive, limited warranties applicable to Microchip products, please see Microchip's standard terms and conditions of sale, which are printed on our sales documentation and available at www.microchip.com.

Signed for and on behalf of Microchip Technology Inc. at Chandler, Arizona, USA.

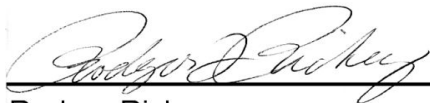

Rodger Richey
Director of Development Tools

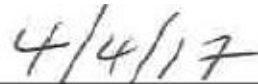

Date

2. Introduction

2.1 Features

- ATSAME54P20A microcontroller
- One mechanical reset button
- One mechanical programmable button
- One QTouch[®] PTC button
- One yellow user LED
- 256 Mb QSPI Flash
- ATECC508 CryptoAuthentication[™] device
- AT24MAC402 serial EEPROM with EUI-48[™] MAC address
- Ethernet
 - RJ45 connector with built-in magnetics
 - KSZ8091RNA PHY
 - 10Base-T/100Base-TX IEE 802.3 compliant Ethernet transceiver
- SD/SDIO card connector
- Parallel Capture Controller header (ArduCAM compatible)
- CAN connector
- Backup super capacitor
- 32.768 kHz crystal
- 12 MHz crystal
- USB interface, host, and device
- Three Xplained Pro extension headers
- 10-pin Cortex[®] Debug Connector with SWD
- 20-pin Cortex Debug + ETM Connector with SWD and four bit trace
- Embedded Debugger
 - Auto-ID for board identification in Atmel Studio
 - One yellow status LED
 - One green board power LED
 - Symbolic debug of complex data types including scope information
 - Programming and debugging, including power measurements
 - Data Gateway Interface: SPI, I²C, four GPIOs
 - Virtual COM port (CDC)
- Embedded current measurement circuitry (XAM)
 - Measures power consumption of the ATSAME54P20A and / or peripherals
 - Measures current between 100 nA and 400 mA
 - Current measurement data shown in Microchip [Data Visualizer](#)
- USB powered
- Supported with application examples in Atmel START

2.2 Kit Overview

The SAM E54 Xplained Pro evaluation kit is a hardware platform to evaluate the ATSAME54P20A.

The kit offers a set of features that enables the ATSAME54P20A user to get started with the SAM E54 peripherals right away and to get an understanding of how to integrate the device in their own design.

Figure 2-1. SAM E54 Xplained Pro Evaluation Kit Overview

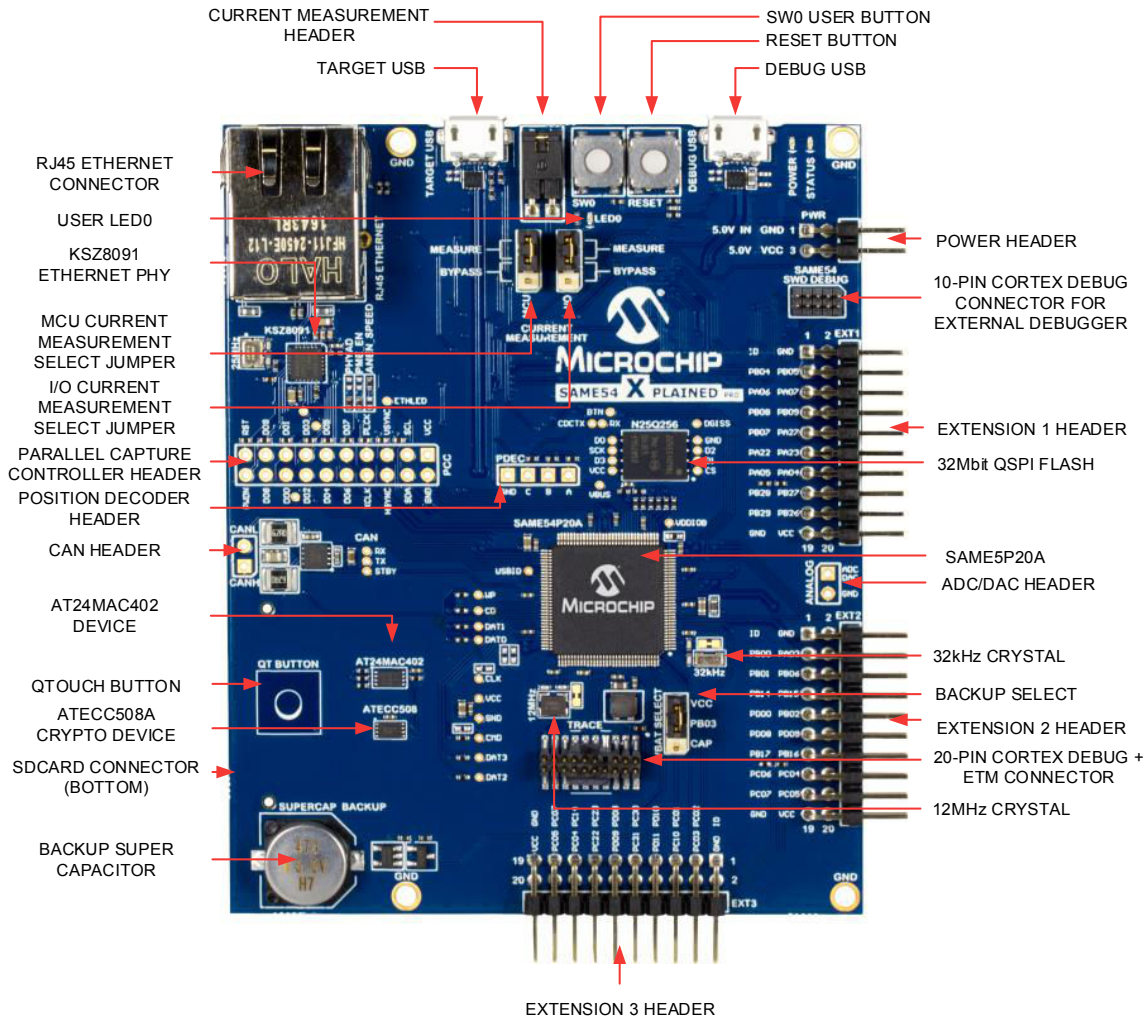

3. Getting Started

3.1 Xplained Pro Quick Start

Steps to start exploring the Xplained Pro platform:

1. Download and install [Atmel Studio](#).
2. Launch Atmel Studio.
3. Connect the DEBUG USB port on the evaluation kit to the computer using a USB cable (Standard-A to Micro-B or Micro-AB).

The operating system installs the driver software automatically the first time the Xplained Pro evaluation kit is connected to a PC. This driver supports 32-bit and 64-bit versions of Microsoft® Windows® XP, Windows Vista®, Windows 7, Windows 8, Windows 10, and Windows Server 2012.

When the Xplained Pro MCU board is powered, the power LED (green) glows and Atmel Studio automatically detects the specific Xplained Pro MCU and extension board(s) that are connected. The kit landing page in Atmel Studio comes with an option to launch Atmel Software Framework (ASF) and Atmel START example application codes for the kit. The SAM E54 device is programmed and debugged by the on-board Embedded Debugger and therefore no external programmer or debugger tool is required.

3.2 Design Documentation and Relevant Links

The following list contains links to the most relevant documents and software for the SAM E54 Xplained Pro.

- **Xplained products** - Xplained evaluation kits are a series of easy-to-use evaluation kits for Microchip microcontrollers and other Microchip products.
 - Xplained Nano: used for low pin-count devices and provides a minimalistic solution with access to all I/O pins of the target microcontroller.
 - Xplained Mini: used for medium pin-count devices and adds Arduino Uno compatible header footprint and a prototyping area.
 - Xplained Pro: used for medium to high pin-count devices that features advanced debugging and standardized extensions for peripheral functions.

Note: All the above kits have on-board programmers/debuggers, which creates a set of low-cost boards for evaluation and demonstration of features and capabilities of different Microchip products.

- **Atmel Studio** - Free IDE for the development of C/C++ and assembler code for microcontrollers.
- **EDBG User Guide** - User guide containing more information about the on-board Embedded Debugger.
- **IAR Embedded Workbench® for ARM®** - This is a commercial C/C++ compiler that is available for ARM®. There is a 30 day evaluation version as well as a code size limited kick-start version available from their website. The code size limit is 16KB for devices with M0, M0+, and M1 cores and 32KB for devices with other cores.
- **QTouch® tools** - A collection of tools to design capacitive touch applications.
- **<http://start.atmel.com/>** - Atmel START is an online tool to help you select and configure software components and tailor your embedded application in a usable and optimized manner.

- [Data Visualizer](#) - Data Visualizer is a program used for processing and visualizing data. The Data Visualizer can receive data from various sources such as the Embedded Debugger Data Gateway Interface found on Xplained Pro boards and COM Ports.
- [SAM E54 Xplained Pro website](#) - Kit information, latest user guide and design documentation.
- [SAM E54 Xplained Pro on Microchip Direct](#) - Purchase this kit on Microchip Direct.

4. Xplained Pro

Xplained Pro is an evaluation platform which contains a series of microcontroller boards (evaluation kits) and extension boards. Atmel Studio is used to program and debug the microcontrollers on these boards. Atmel Studio includes ASF and Atmel START, which has drivers and demo code, and Data Visualizer, which supports data streaming and advanced debugging. Xplained Pro evaluation kits can be connected to a wide range of Xplained Pro extension boards through standardized headers and connectors. Xplained Pro extension boards have identification (ID) chips to uniquely identify which boards are connected to the Xplained Pro evaluation kits.

4.1 Embedded Debugger

The SAM E54 Xplained Pro contains an Embedded Debugger (EDBG) for on-board debugging. The EDBG is a USB composite device with the following interfaces:

- Debugger
- Virtual COM Port
- Data Gateway Interface (DGI)

The EDBG can program and debug the ATSAME54P20A with the help of Atmel Studio. The SWD interface is connected between the EDBG and the ATSAME54P20A on the SAM E54 Xplained Pro.

The Virtual COM Port is connected to a UART on the ATSAME54P20A and provides an easy way to communicate with the target application through terminal software. It offers variable baud rate, parity, and stop bit settings. The settings on the ATSAME54P20A must match the settings given in the terminal software.



Info: The Virtual COM Port in the EDBG requires the terminal software to set the Data Terminal Ready (DTR) signal to enable the UART pins connected to the ATSAME54P20A. If the DTR signal is not enabled, the UART pins on the EDBG are kept in tri-state (high-z) to render the COM Port not usable. The DTR signal is automatically set by some terminal software, but it may have to be manually enabled in your terminal.

The DGI consists of several physical interfaces for bidirectional communication with the host computer. Communication over the interfaces is bidirectional. It can be used to send event values, and data from the ATSAME54P20A. Traffic over the interfaces can be timestamped by the EDBG for more accurate tracing of events, but timestamping reduces the maximal data throughput. The [Data Visualizer](#) is used to send and receive data through DGI.

The EDBG controls two LEDs on the SAM E54 Xplained Pro: a power LED and a status LED. The table below shows how the LEDs are controlled in different operation modes.

Table 4-1. EDBG LED Control

Mode	Power LED	Status LED
Normal mode	The power LED is on when power is applied to the board.	Activity indicator, the LED flashes when any communication happens to the EDBG.
Bootloader mode (idle)	The power LED and the status LED blink simultaneously.	
Bootloader mode (firmware upgrade)	The power LED and the status LED blink in an alternating pattern.	

For additional information on the EDBG, see the [EDBG User Guide](#).

4.2 Xplained Pro Analog Module (XAM)

4.2.1 Overview

The Xplained Pro Analog Module (XAM) extends the embedded debugger with high dynamic range current measurement. This enables power profiling of the target system.

Figure 4-1. XAM Block Diagram

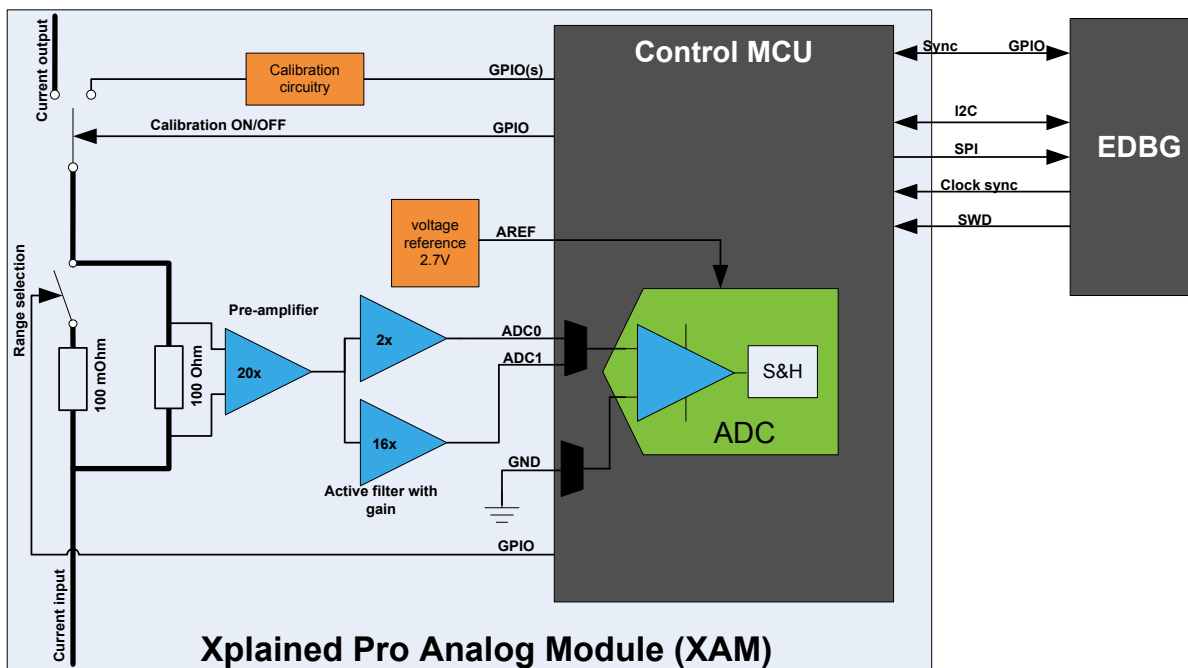

The XAM consists of:

- Calibration circuitry
- Voltage reference circuitry
- Analog front-end:
 - Shunt resistors with a range selection switch
 - Pre-amplifier
 - Two active filters with gain
- Control MCU

- Analog-to-Digital Converter
- Signal processing
- Control/communication interface to the EDBG

The current measurement front-end is a high side shunt measurement with a pre-amplifier and a second active filter stage with gain as shown in [Figure 4-1](#). The wide dynamic range is achieved by four measurement ranges, which are defined by two shunt resistors and the two parallel second stage active filters with gain.

4.2.2 EDBG Interface

The XAM is connected to the EDBG with the following interfaces:

- **I²C**: This is used to control and configure the XAM.
- **SPI**: Current measurement data is streamed to the EDBG via this interface. This is a unidirectional channel from the XAM to the EDBG.
- **SWD**: The MCU in the XAM is programmed via SWD from the EDBG.
- **Clock sync**: Signal used to synchronize ADC measurements with the EDBG.
- **Reference clock**: Reference clock for the XAM.

4.2.3 Sample Rate

The raw sampling rate of the XAM is up to 250 kHz and with the default averaging configuration (average of 16 samples), the actual output of the XAM is 16.67 ksps.



Info: The XAM output sample rate is not an integer fraction of the raw sampling.

4.2.4 Measurement Ranges and Accuracy

The XAM has four measurement ranges. These are defined by two shunt resistors and two gain stages.

Table 4-2. XAM Measurement Ranges and Accuracy

Measurement Range	Hardware	Resolution	Accuracy	Comments
Range 1	Low current shunt and high gain stage	20 nA	1 LSB \pm 1%	Accuracy will decrease below 1 μ A. Typical accuracy for 300nA is 1 LSB \pm 10%.
Range 2	Low current shunt and low gain stage	150 nA	1 LSB \pm 1%	
Range 3	High current shunt and high gain stage	10 μ A	1 LSB \pm 1%	
Range 4	High current shunt and low gain stage	100 μ A	1 LSB \pm 1%	Accuracy will decrease above 100 mA. Typical accuracy is 1 LSB \pm 5% at 400 mA. Maximum current is 400 mA.

The ranges are automatically switched by the XAM to achieve the best measurement results and the currently active range is visualized in the [Data Visualizer](#) front-end tool. The maximum voltage drop over the shunt resistor is 100 mV, and the XAM switches the range automatically before reaching this limit.

4.3 Hardware Identification System

All Xplained Pro extension boards come with an identification chip (ATSHA204A CryptoAuthentication™ chip) to uniquely identify the boards that are connected to the Xplained Pro evaluation kit. This chip contains information that identifies the extension with its name and some extra data. When an Xplained Pro extension is connected to an Xplained Pro evaluation kit, the information is read and sent to Atmel Studio. The following table shows the data fields stored in the ID chip with example content.

Table 4-3. Xplained Pro ID Chip Content

Data Field	Data Type	Example Content
Manufacturer	ASCII string	Atmel\0'
Product Name	ASCII string	Segment LCD1 Xplained Pro\0'
Product Revision	ASCII string	02\0'
Product Serial Number	ASCII string	1774020200000010\0'
Minimum Voltage [mV]	uint16_t	3000
Maximum Voltage [mV]	uint16_t	3600
Maximum Current [mA]	uint16_t	30

4.4 Power Sources

The SAM E54 Xplained Pro kit can be powered by several power sources, as listed in the table below.

Table 4-4. Power Sources for SAM E54 Xplained Pro

Power Source	Voltage Requirements	Current Requirements	Connector Marking
External Power	5V ±2% (±100mV) for USB host operation. 4.3V to 5.5V if a USB host operation is not required.	In USB host applications a minimum of 1A is recommended to supply the kit and the USB device. Maximum recommended current is 2A.	PWR
Embedded debugger USB	4.4V to 5.25V (according to USB spec.)	500 mA (according to USB spec.)	DEBUG USB
Target USB	4.4V to 5.25V (according to USB spec.)	500 mA (according to USB spec.)	TARGET USB

The kit automatically detects which power sources are available and chooses which one to use according to the following priority:

1. External power.

2. Embedded Debugger USB.
3. Target USB.



Info: External power is required when 500mA from a USB connector is not enough to power the board with possible extension boards. A connected USB device in a USB host application might easily exceed this limit.

4.5 Xplained Pro Headers and Connectors

4.5.1 Xplained Pro Standard Extension Header

All Xplained Pro kits have one or more dual row, 20-pin, 100-mil extension header. The Xplained Pro MCU boards have male headers, while the Xplained Pro extensions have their female counterparts. All connected pins follow the defined pin description in the table.



Info: All pins are not always connected on all extension headers.

The extension headers can be used to connect a variety of Xplained Pro extensions to Xplained Pro MCU boards or to access the pins of the target microcontroller on Xplained Pro MCU boards directly.

Table 4-5. Xplained Pro Standard Extension Header

Pin Number	Pin Name	Description
1	ID	Pin to communicate with the ID chip on an extension board
2	GND	Ground
3	ADC(+)	Analog-to-Digital Converter; alternatively, a pin for the positive terminal of a differential ADC
4	ADC(-)	Analog-to-Digital Converter; alternatively, a pin for the negative terminal of a differential ADC
5	GPIO1	General purpose I/O pin
6	GPIO2	General purpose I/O pin
7	PWM(+)	Pulse width modulation; alternatively, a pin for the positive part of a differential PWM
8	PWM(-)	Pulse width modulation; alternatively, a pin for the negative part of a differential PWM
9	IRQ/GPIO	Interrupt request pin and/or general purpose I/O pin
10	SPI_SS_B/ GPIO	Slave select pin for Serial Peripheral Interface (SPI) and/or general purpose I/O pin
11	I ² C_SDA	Data pin for I ² C interface. Always connected, bus type
12	I ² C_SCL	Clock pin for I ² C interface. Always connected, bus type

Pin Number	Pin Name	Description
13	UART_RX	Receiver pin of target device UART
14	UART_TX	Transmitter pin of target device UART
15	SPI_SS_A	Slave select for SPI. This pin should preferably not be connected to anything else.
16	SPI_MOSI	SPI master out slave in pin. Always connected, bus type
17	SPI_MISO	SPI master in slave out pin. Always connected, bus type
18	SPI_SCK	SPI clock pin. Always connected, bus type
19	GND	Ground pin for extension boards
20	VCC	Power pin for extension boards

4.5.2 Xplained Pro Power Header

The power header can be used to connect external power to the SAM E54 Xplained Pro kit. The kit automatically detects and switches to any external power if supplied. The power header can also be used to supply power to external peripherals or extension boards. Ensure that the total current does not exceed the recommended current limit of the on-board regulator when using the 3.3V pin.

Table 4-6. Xplained Pro Power Header

Pin Number	Pin Name	Description
1	VEXT_P5V0	External 5V input pin
2	GND	Ground pin
3	VCC_P5V0	Unregulated 5V pin (an output, derived from one of the input sources)
4	VCC_P3V3	Regulated 3.3V pin (an output, used as main power supply for the kit)

5. Hardware User Guide

5.1 Power Distribution

SAM E54 Xplained Pro has three power sources: EDBG USB, Target USB, and/or external 5.0V. The kit will automatically select a source to draw power from. The kit has two on-board 3.3V voltage regulators, one for the EDBG and XAM, and one for the ATSAME54P20A and other peripherals.

An onboard super capacitor (47 mF) is charged to 3.3V from the target 3.3V net. The super capacitor is connected to PB03 (VBAT) through a selection header and is intended for backup use in sleep modes.

Figure 5-1. Power Supply Block Diagram

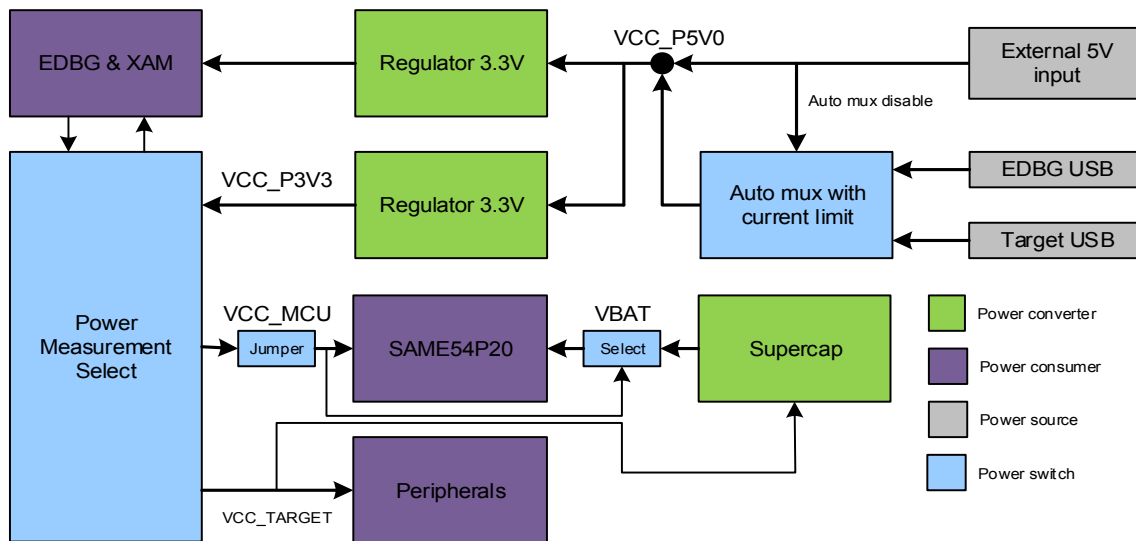

5.2 Connectors

The following sections describes the implementation of the relevant connectors and headers on SAM E54 Xplained Pro and their connection to the ATSAME54P20A. The tables of connections in the sections also describes which signals are shared between the headers and on-board functionality. The figure below shows all available connectors and jumpers on SAM E54 Xplained Pro.

Figure 5-2. SAM E54 Xplained Pro Connector Overview

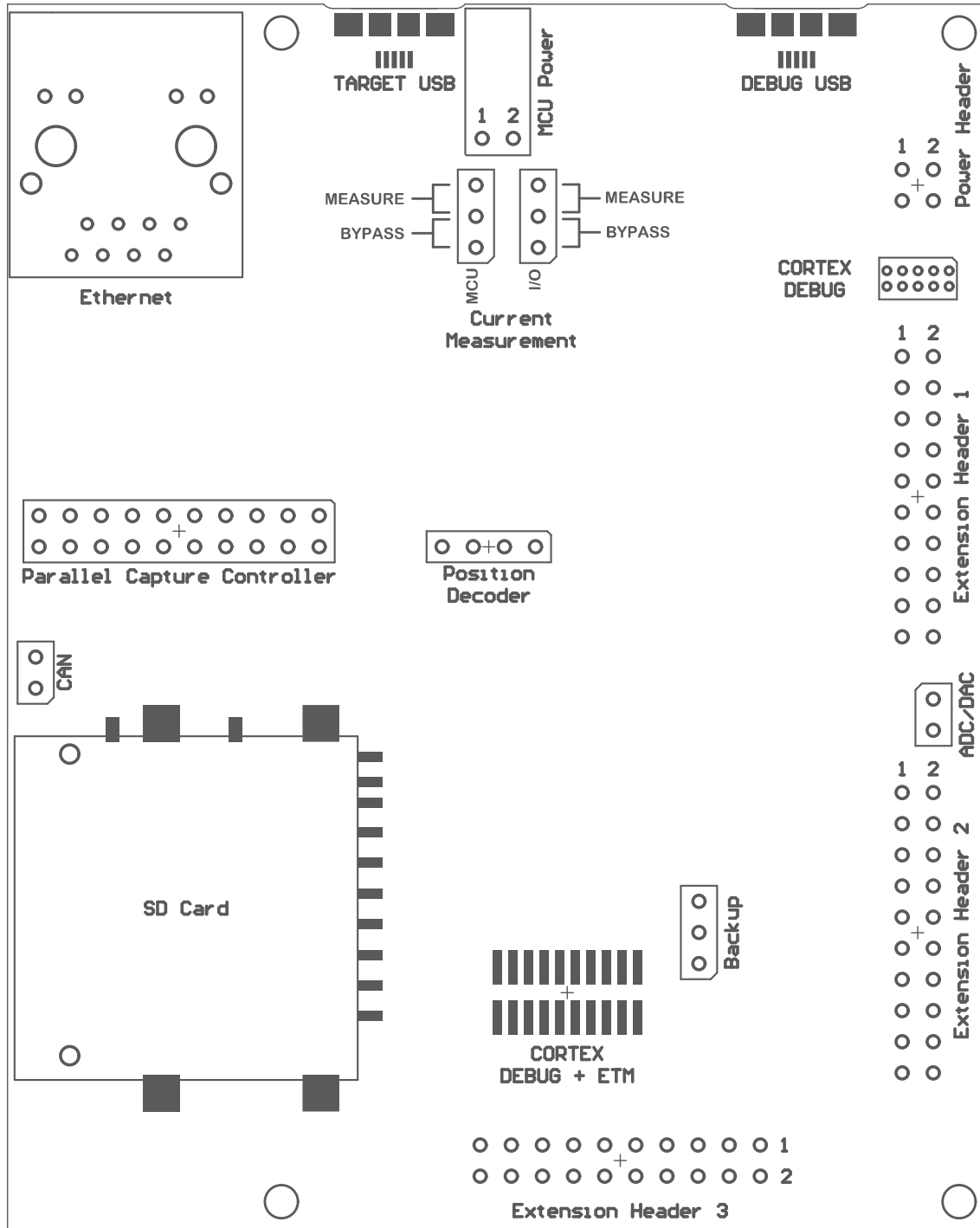

5.2.1 Xplained Pro Standard Extension Headers

The Xplained Pro extension headers EXT1, EXT2, and EXT3 offer access to the I/O of the microcontroller to expand the board, for example, by connecting extensions to the board. These headers are based on the standard Xplained Pro extension header specification and the connections are shown in the table below. The headers have a pitch of 2.54 mm.

Table 5-1. Extension Header EXT1

EXT1 pin	SAM E54 pin	Function	Shared functionality
1 [ID]	-	-	Communication line to the ID chip on an extension board
2 [GND]	-	-	Ground
3 [ADC(+)]	PB04	ADC1/AIN[6]	-
4 [ADC(-)]	PB05	ADC1/AIN[7]	-
5 [GPIO1]	PA06	GPIO (RTS)	-
6 [GPIO2]	PA07	GPIO (CTS)	-
7 [PWM(+)]	PB08	TC4/WO[0]	-
8 [PWM(-)]	PB09	TC4/WO[1]	-
9 [IRQ/GPIO]	PB07	IRQ7/GPIO	-
10 [SPI_SS_B/GPIO]	PA27	GPIO	-
11 [TWI_SDA]	PA22	SERCOM3 PAD[0] I ² C SDA	PCC
12 [TWI_SCL]	PA23	SERCOM3 PAD[1] I ² C SCL	PCC
13 [USART_RX]	PA05	SERCOM0 PAD[1] UART RX	-
14 [USART_TX]	PA04	SERCOM0 PAD[0] UART TX	-
15 [SPI_SS_A]	PB28	SERCOM4 PAD[2] SPI SS	-
16 [SPI_MOSI]	PB27	SERCOM4 PAD[0] SPI MOSI	-
17 [SPI_MISO]	PB29	SERCOM4 PAD[3] SPI MISO	-
18 [SPI_SCK]	PB26	SERCOM4 PAD[1] SPI SCK	-
19 [GND]	-	-	Ground
20 [VCC]	-	-	Power for extension board

Table 5-2. Extension Header EXT2

EXT2 pin	SAM E54 pin	Function	Shared functionality
1 [ID]	-	-	Communication line to the ID chip on an extension board
2 [GND]	-	-	Ground
3 [ADC(+)]	PB00	ADC0/AIN[12]	-
4 [ADC(-)]	PA03	ADC0/AIN[1]	-
5 [GPIO1]	PB01	GPIO	-
6 [GPIO2]	PB06	GPIO	-
7 [PWM(+)]	PB14	TCC4/WO[4]	PCC

EXT2 pin	SAM E54 pin	Function	Shared functionality
8 [PWM(-)]	PB15	TCC4/WO[5]	PCC
9 [IRQ/GPIO]	PD00	IRQ0/GPIO	-
10 [SPI_SS_B/GPIO]	PB02	GPIO	-
11 [TWI_SDA]	PD08	SERCOM7 PAD[0] I ² C SDA	AT24MAC402, ATECC508, PCC, EXT3, and EDBG DGI
12 [TWI_SCL]	PD09	SERCOM7 PAD[1] I ² C SCL	AT24MAC402, ATECC508, PCC, EXT3, and EDBG DGI
13 [USART_RX]	PB17	SERCOM5 PAD[1] UART RX	-
14 [USART_TX]	PB16	SERCOM5 PAD[0] UART TX	-
15 [SPI_SS_A]	PC06	SERCOM6 PAD[2] SPI SS	-
16 [SPI_MOSI]	PC04	SERCOM6 PAD[0] SPI MOSI	EXT3 and EDBG DGI
17 [SPI_MISO]	PC07	SERCOM6 PAD[3] SPI MISO	EXT3 and EDBG DGI
18 [SPI_SCK]	PC05	SERCOM6 PAD[1] SPI SCK	EXT3 and EDBG DGI
19 [GND]	-	-	Ground
20 [VCC]	-	-	Power for extension board

Table 5-3. Extension Header EXT3

EXT3 pin	SAM E54 pin	Function	Shared functionality
1 [ID]	-	-	Communication line to the ID chip on an extension board
2 [GND]	-	-	Ground
3 [ADC(+)]	PC02	ADC1/AIN[4]	
4 [ADC(-)]	PC03	ADC1/AIN[5]	
5 [GPIO1]	PC01	GPIO	
6 [GPIO2]	PC10	GPIO	-
7 [PWM(+)]	PD10	TCC0/WO[3]	-
8 [PWM(-)]	PD11	TCC0/WO[4]	-
9 [IRQ/GPIO]	PC30	IRQ14/GPIO	-
10 [SPI_SS_B/GPIO]	PC31	GPIO	-
11 [TWI_SDA]	PD08	SERCOM7 PAD[0] I ² C SDA	AT24MAC402, ATECC508, PCC, EXT2, and EDBG DGI
12 [TWI_SCL]	PD09	SERCOM7 PAD[1] I ² C SCL	AT24MAC402, ATECC508, PCC, EXT2, and EDBG DGI

EXT3 pin	SAM E54 pin	Function	Shared functionality
13 [USART_RX]	PC23	SERCOM1 PAD[1] UART RX	-
14 [USART_TX]	PC22	SERCOM1 PAD[0] UART TX	-
15 [SPI_SS_A]	PC14	GPIO	-
16 [SPI_MOSI]	PC04	SERCOM6 PAD[0] SPI MOSI	EXT2 and EDBG DGI
17 [SPI_MISO]	PC07	SERCOM6 PAD[3] SPI MISO	EXT2 and EDBG DGI
18 [SPI_SCK]	PC05	SERCOM6 PAD[1] SPI SCK	EXT2 and EDBG DGI
19 [GND]	-	-	Ground
20 [VCC]	-	-	Power for extension board

5.2.2 SD/SDIO Card

SAM E54 Xplained Pro has one standard SD card connector which is connected to the SD/MMC Host Controller (SDHC) of the SAM E54. The table below lists all I/O-lines connected to the SD card connector.

Table 5-4. SD/SDIO Card Connection

SAM E54 pin	Function	Shared functionality
PB18	MCDA0 (DAT0)	
PB19	MCDA1 (DAT1)	
PB20	MCDA2 (DAT2)	
PB21	MCDA3 (DAT3)	
PA21	MCCK (CLK)	PCC
PA20	MCCDA (CMD)	PCC
PD20	Card Detect (C/D)	-
PD21	Write Protect (WP)	-

5.2.3 PCC Camera Connector

A 2x10, 100-mil pin-header footprint for camera connector is implemented to give access to the SAM E54's Parallel Capture Controller (PCC). The footprint is compatible with common ArduCAM modules.



Info: The PCC connector is not functional by default due to shared functionality with Ethernet, QTouch, SD Card, EXT1, and EXT2. If using the PCC, you will partially or fully lose the ability to use these other functions.



Info: Soldering is required to get the PCC functional. Refer to [Kit Modifications](#) for details on modifications needed.



Tip: The DEN1 and DEN2 signals connected to VSYNC and HSYNC on the PCC camera connector are used to tell the PCC module when there is valid data to sample on the data pins. If interrupts are required when the DEN1 and DEN2 signals changes, the I/O pins (PA12 and PA13) has to be multiplexed to the EIC function in the GPIO module. The PCC module will still sample the DEN pins when they are multiplexed to the EIC function.

Table 5-5. PCC Camera Connector

Pin number	SAM E54 pin	Function	Shared functionality
1 [VCC]	-	VCC_TARGET_P3V3	
2 [GND]	-	GND	
3 [SCL]	PD09	SERCOM7 PAD[1] I ² C SCL	AT24MAC402, ATECC508, EXT2, EXT3, and EDBG DGI
4 [SDA]	PD08	SERCOM7 PAD[0] I ² C SDA	AT24MAC402, ATECC508, EXT2, EXT3, and EDBG DGI
5 [VSYNC]	PA12	PCC_DEN1	Ethernet
6 [HSYNC]	PA13	PCC_DEN2	Ethernet
7 [PCLK]	PA14	PCC_CLK	Ethernet
8 [XCLK]	PA15	GCLK_IO1	Ethernet
9 [DOUT07]	PA23 ¹⁾	PCC_DATA7	EXT1
10 [DOUT06]	PA22 ¹⁾	PCC_DATA6	EXT1
11 [DOUT05]	PA21 ¹⁾	PCC_DATA5	SD Card
12 [DOUT04]	PA20 ¹⁾	PCC_DATA4	SD Card
13 [DOUT03]	PA19	PCC_DATA3	Ethernet
14 [DOUT02]	PA18	PCC_DATA2	Ethernet
15 [DOUT01]	PA17	PCC_DATA1	Ethernet
16 [DOUT00]	PA16	PCC_DATA0	QTouch
17 [DOUT09]	PB15	PCC_DATA9	EXT2
18 [DOUT08]	PB14	PCC_DATA8	EXT2
19 [RESET]	PC12	GPIO	Ethernet
20 [PWDN]	PC11	GPIO	Ethernet



Info:

1) Connected through a 0Ω resistor. Not connected by default.

5.2.4 Position Decoder

SAM E54 Xplained Pro has a header footprint for the position decoder module. The PDEC can be used for quadrature, hall, and counter decoding.



Info: External pull-ups are mounted on the three signal lines for use with passive quadrature encoders.

Table 5-6. PDEC Header

J407 pin	SAM E54 pin	Function	Shared functionality
1 [PHASE A]	PC16	PDEC QDI[0]	EDBG GPIO0
2 [PHASE B]	PC17	PDEC QDI[1]	EDBG GPIO1
3 [INDEX]	PC18	PDEC QDI[2]	EDBG GPIO2 and User LED
4	-	GND	-

5.2.5 VBAT Backup Select

There is a 1x3, 100mil pin-header on the kit that can be used to select a power source for the VBAT pin (PB03) marked "VBAT Select". The power source can either be the onboard 3.3V that supplies the other peripherals on the board, or the onboard super capacitor. To select the source for the VBAT pin, move the jumper to the desired voltage by placing the jumper between pin 1-2 for the super capacitor, or between pin 2-3 for the targets MCU voltage. If power to the VBAT pin is not needed, the jumper can be removed and PB03 at the center pin can be used as a GPIO.

Table 5-7. VBAT Select Header

Pin	Function	Description
1	VCC_SUPERCAP	Power from super capacitor
2	PB03	VBAT input pin on SAM E54
3	VCC_MCU_P3V3	Power from the target MCU supply

5.2.6 ADC/DAC Header

There is a 1x2, 100mil pin-header on the kit that can be used for connecting analog peripherals for use with the built in ADC or DAC.

Table 5-8. ADC/DAC Header

Pin number	Pin/Net	Function	Shared functionality
1	PA02	ADC0/AIN0 or DAC/VOUT0	-
2	GND	Ground	-

5.2.7 USB

SAM E54 Xplained Pro has a USB Micro-AB connector for use with the SAM E54 USB module labeled TARGET USB on the kit. To be able to detect when a target USB cable is connected in self-powered mode, a GPIO is used to detect the VBUS voltage on the connector. The USB ID is connected to a power switch, which will automatically enable power to the USB port if a device cable is detected. The USB ID

signal is connected to PC19, which can force power from the kit to the USB connector by driving PC19 low. It is not possible to override and disable the power if a device is connected as the device cable will short the USB ID to ground.

Table 5-9. USB Connections

SAM E54 pin	USB function
PC00	VBUS Detection
PC19	USB ID
PA24	USB D-
PA25	USB D+

5.2.8 Cortex Debug Connector

SAM E54 Xplained Pro has a 10-pin 50-mil Cortex Debug Connector with SWD that can be used to attach external debuggers to the ATSAME54P20A. Microchip debugging tools like the Atmel-ICE and Power Debugger can connect directly to this connector.

Table 5-10. Cortex Debug Connector

Cortex Debug Connector pin	Pin/Net	Function	Shared functionality
1 [VCC]	VCC_TARGET_P3V3	ATSAME54P20A voltage	
2 [SWDIO/TMS]	PA31	SW bidirectional data	TRACE and EDBG SWD
3 [GND]	GND	Ground	
4 [SWCLK/TCK]	PA30	SW clock signal	TRACE and EDBG SWD
5 [GND]	GND	Ground	
6 [SWO/TDO]	PB30	SW output	TRACE and EDBG SWD
7 [KEY]	-	-	
8 [NC/TDI]	-	-	
9 [GNDDetect]	GND	Ground	
10 [nRESET]	RESETN	Target reset signal	RST BTN, TRACE, and EDBG SWD

5.2.9 Cortex Debug Connector with Trace

ATSAME54P20A supports 4-bit parallel trace. SAM E54 Xplained Pro implements a 20-pin, 50-mil [Cortex Debug + ETM Connector](#) with SWD and 4-bit parallel trace. The connector is keyed (pin 7 is removed).

To use the parallel trace functionality an external debugger with trace support and 20-pin Cortex Debug + ETM Connector pin-out has to be used. The table below shows the connections on the kit.

Table 5-11. Cortex Debug + ETM Connector

Pin number	Pin/Net	Function	Shared functionality
1 [VTREF]	VCC_TARGET_P3V3	ATSAME54P20A voltage	
2 [TMS/SWDIO]	PA31	SWDIO	Cortex DBG and EDBG SWD
3 [GND]	GND	Ground	
4 [TCK/SWCLK]	PA30	SWCLK	Cortex DBG and EDBG SWD
5 [GND]	GND	Ground	
6 [TDO/SWO]	PB30	SWO	Cortex DBG and EDBG SWD
7 [KEY]	-	Not connected, the pin is removed.	
8 [TDI]	-	-	
9 [GND]	GND	Ground	
10 [nSRST]	RESET_N	Reset	RST BTN, Cortex DBG, and EDBG SWD
11 [NC]	-	-	
12 [RTCK/TRACECLK]	PC27	TRACECLK	
13 [NC]	-	-	
14 [SWO/D0]	PC28	TRACEDATA[0]	
15 [GND]	GND	Ground	
16 [ntRST/D1]	PC26	TRACEDATA[1]	
17 [GND]	GND	Ground	
18 [DBGRRQ/D2]	PC25	TRACEDATA[2]	
19 [GND]	GND	Ground	
20 [DBGACK/D3]	PC24	TRACEDATA[3]	

5.2.10 Current Measurement Header

An angled 1x2, 100-mil pin header marked with the MCU current measurement is located at the upper edge of the SAM E54 Xplained Pro. All power to the ATSAME54P20A is exclusively routed through this header (excluding power to headers and peripherals). To measure the power consumption of the device, remove the jumper and replace it with an ammeter.



Caution: Removing the jumper from the pin header while the kit is powered may cause the ATSAME54P20A to be powered through its I/O pins. This may cause permanent damage to the device.

5.3 Peripherals

5.3.1 Crystals

SAM E54 Xplained Pro has a 32.768 kHz and a 12 MHz crystal that can be used as clock source for the SAM E54 device. There are cut-straps located close to the crystals that can be used to measure the oscillator safety factor. This is done by cutting the strap and adding a resistor across the strap. More information about oscillator allowance and safety factor are available in the [AVR4100](#) application note.

The 32.768 kHz crystal on SAM E54 Xplained Pro is a Kyocera Crystal Device Corporation ST3215SB32768A0HPWBB 5pF crystal. The crystal has been matched to be driven in high drive mode by the SAM E54.

The 12 MHz crystal on SAM E54 Xplained Pro is a Kyocera Crystal Device Corporation CX3225CA12000D0KPSC1. The crystal has been matched to be driven with Automatic Loop Control enabled in the SAM E54.

Both crystals have been formally tested and matched to the SAM E54 by Kyocera. The test reports are available in the design documentation distributed with this document for SAM E54 Xplained Pro.



Info: Kyocera Crystal Device Corporation crystals that are matched with specific products can be found on their web site: http://prdct-search.kyocera.co.jp/crystal-ic/?p=en_search/

Table 5-12. External 32.768kHz Crystal

SAM E54 pin	Function
PA00	XIN32
PA01	XOUT32

Table 5-13. External 12MHz Crystal

SAM E54 pin	Function
PB22	XIN1
PB23	XOUT1

Related Links

[Design Documentation and Relevant Links](#)

5.3.2 Mechanical Buttons

SAM E54 Xplained Pro contains two mechanical buttons. One button is the RESET button connected to the SAM E54 reset line and the other is a generic user configurable button. When a button is pressed it will drive the I/O line to GND.



Info: There is no pull-up resistor connected to the generic user button. Remember to enable the internal pull-up in the SAM E54 to use the button.

Table 5-14. Mechanical Buttons

SAM E54 pin	Silkscreen text	Shared functionality
RESET	RESET	Cortex DBG , TRACE , and EDBG SWD
PB31	SW0	EDBG GPIO3

5.3.3 LED

There is one yellow LED available on the SAM E54 Xplained Pro board that can be turned ON and OFF. The LED can be activated by driving the connected I/O line to GND.

Table 5-15. LED Connection

SAM E54 pin	Function	Shared functionality
PC18	Yellow LED0	PDEC and EDBG GPIO2

5.3.4 QTouch Button

There is one self capacitance button available on the SAM E54 Xplained Pro board that can be used as user button. This QTouch button is intended to be driven by the built-in Peripheral Touch Controller (PTC) of the device.



Info: To get started with QTouch, refer to [QTouch® Library](#), or find examples in Atmel START.

Table 5-16. QTouch Connection

SAM E54 pin	Silkscreen text	Shared functionality
PA16	QT BUTTON	PCC

5.3.5 Backup Super Capacitor

SAM E54 Xplained Pro has a 47 mF backup super capacitor for use with the SAM E54 backup system. The super capacitor can be connected to the device as described in [VBAT Backup Select](#).

Due to the high capacitive load represented by the super capacitor, a 220Ω limiting resistor is added to reduce inrush current. The source for charging is the targets main supply and a low-power opamp is used for disconnecting the charger input when removing power. This is added to avoid a current leak back to the main supply from the super capacitor when power is removed.

A full charge of the super capacitor from an empty state will take approximately 45 seconds and can supply the target device in backup mode with ULP running for up to ~20 hours. Other modes are not characterized, but will reduce the available time in backup mode respectively. For more information about the current consumption in other modes, refer to the electrical characteristics chapter in the SAM E54 datasheet.



Caution: Due to an issue with the VBAT pin in the A0 revision of ATSAME54P20A there is an over-consumption of current in the VBAT pin when VBAT > VDDIO. This issue renders the on-board super capacitor backup solution not usable.

Related Links

VBAT Pin

5.3.6 CAN

SAM E54 Xplained Pro has two CAN modules that performs communication according to ISO11898-1 (Bosch CAN specification 2.0 part A,B) and Bosch CAN FD specification V1.0.

CAN1 is connected to an on-board [ATA6561](#) CAN physical-layer transceiver, the table below shows connections between the ATSAME54P20A and the ATA6561.

Table 5-17. ATA6561 Connections

SAM E54 pin	Function	ATA6561 function	Shared functionality
PB12	CAN1/TX	TXD	-
PB13	CAN1/RX	RXD	-
PC13	GPIO	Standby	-

5.3.7 Ethernet

ATSAME54P20A has a built-in 10/100Mbps Ethernet IEEE® 802.3 compatible MAC with RMII interface. The MAC also supports energy efficient Ethernet (IEEE 802.3az). SAM E54 Xplained Pro connects the MAC to a Micrel *KSZ8091RNACA* RMII physical-layer transceiver (PHY), with IEEE 802.3az support, which is connected to one RJ45 Ethernet connector.

A unique EUI-48 address is available on every SAM E54 Xplained Pro through the onboard [AT24MAC402](#), the EUI-48 address can be used as a MAC address for the *KSZ8091RNACA*. The address is also programmed into the onboard EDBG. For more information, see [Kit Specific Data](#).

The table below lists all pins connected from the ATSAME54P20A to the Ethernet PHY.



Info: Several of the Ethernet signals are shared with the [PCC](#) connector. This means that there is no Ethernet support if [PCC](#) is used in an application.

Table 5-18. KSZ8061RNBW Connections

SAM E54 pin	Function	Ethernet function	Shared functionality
PA14	GTXCK	REF_CLK	PCC
PA17	GTXEN	TXEN	PCC
PA18	GTX0	TXD0	PCC
PA19	GTX1	TXD1	PCC
PC20	GRXDV	CRS_DV	
PA13	GRX0	RXD0	PCC
PA12	GRX1	RXD1	PCC
PA15	GRXER	RXER	PCC
PC11	GMDC	MDC	PCC
PC12	GMDIO	MDIO	PCC

SAM E54 pin	Function	Ethernet function	Shared functionality
PD12	GPIO	INTERRUPT	
PC21	GPIO	RESET	

The *KSZ8091RNACA* also has a set of parameters that are latched in during reset based on I/O pin levels. These configuration options have a default mode on the kit done by external pull-up and pull-down resistors. For detailed information about the configuration, see the *KSZ8091RNACA* datasheet.

Table 5-19. KSZ8091RNACA Kit Configuration

Configuration name	Default value on kit	Default configuration
PHYAD	00	The PHYs address is 00000
PME_EN	0	Disable PME Enable output for Wake-On-LAN
ANEN_SPEED	1	Auto negotiation enabled and 100Mbps link speed enabled

5.3.8 AT24MAC402

SAM E54 Xplained Pro features one external [AT24MAC402](#) serial EEPROM with a EIA-48 MAC address connected to the SAM E54 through I²C. This device contain a MAC address for use with the [Ethernet](#) interface. The table below lists all I/O-lines connected to the ATMAC402 device.



Info: The I²C EEPROM address is 0x56 and extended address is 0x5E (7-bit, right adjusted without R/W bit).

Table 5-20. AT24MAC402 Connections

AT24MAC402 pin	SAM E54 pin	Function	Shared functionality
1 [A0]	-	Address bit 0 config (Pulled to GND)	-
2 [A1]	-	Address bit 1 config (Pulled to VCC)	-
3 [A2]	-	Address bit 2 config (Pulled to VCC)	-
4 [GND]	-	GND	-
5 [SDA]	PD08	SERCOM7 PAD[0] I ² C SDA	ATECC508 , PCC , EXT2 , EXT3 , and EDBG DGI
6 [SCL]	PD09	SERCOM7 PAD[1] I ² C SCL	ATECC508 , PCC , EXT2 , EXT3 , and EDBG DGI
7 [WP]	-	Write Protect (Pulled to GND)	-

AT24MAC402 pin	SAM E54 pin	Function	Shared functionality
8 [VCC]	-	VCC_TARGET_P3V3	-
9 [PAD]	-	-	-

5.3.9 ATECC508A

SAM E54 Xplained Pro implements a [ATECC508A](#) Crypto Authentication device. The table below shows all the connections between the ATECC508A and the ATSAME54P20A.



Info: The I²C address is 0x60 (7-bit, right adjusted without R/W bit).

Table 5-21. ATECC508A Connections

ATECC508A pin	SAM E54 pin	Function	Shared functionality
1 [NC]	-	-	-
2 [NC]	-	-	-
3 [NC]	-	-	-
4 [GND]	-	GND	-
5 [SDA]	PD08	SERCOM7 PAD[0] I ² C SDA	AT24MAC402 , PCC , EXT2 , EXT3 , and EDBG DGI
6 [SCL]	PD09	SERCOM7 PAD[1] I ² C SCL	AT24MAC402 , PCC , EXT2 , EXT3 , and EDBG DGI
7 [NC]	-	-	-
8 [VCC]	-	VCC_TARGET_P3V3	-
9 [PAD]	-	GND	-

5.3.10 QSPI Flash

The SAM E54 Xplained Pro features one external MICRON, N25Q256A, 256Mbit QSPI NOR Flash Memory. QSPI Flash access can be configured in the QSPI module in the SAM E54, with support for XIP to run firmware directly from external flash. The table below lists all I/O-lines connected to the QSPI Flash.



Info: The PCB tracks between the QSPI flash and the ATSAME54P20A are routed with 60Ω impedance. The I/O drivers in the ATSAME54P20A should be set in high drive mode. The QSPI flash I/O drive level can be configured to match 60Ω tracks in configuration registers in the QSPI flash, refer to the QSPI datasheet for more information.

Table 5-22. QSPI Flash Connections

SAM E54 pin	Function	QSPI Flash function	Shared functionality
PA08	QIO0	Slave In/IO0	-
PA09	QIO1	Slave Out/IO1	-
PA10	QIO2	Write Protect/IO2	-
PA11	QIO3	Hold/IO3	-
PB10	QSCK	Clock	-
PB11	QCS	Chip Select	-

5.3.11 I²S Signals

The ATSAME54P20A has a built in two channel Inter-IC Sound Controller (I²S).

There is no on-board IC connected to this module, but the signals are available on the different pin-headers on the kit as shown in the table below.

Table 5-23. I²S Signals on SAM E54 Xplained Pro

Microcontroller Pin	I ² S Signal	Pin-Header Location	On-board Shared
PB16	SCK0	EXT2 pin 14	
PB17	MCK0	EXT2 pin 13	
PA20	FS0	Camera pin 12 ¹⁾	SDCARD MCCDA
PA21	SDO	Camera pin 11 ¹⁾	SDCARD MCCK
PA22	SDI	EXT1 pin 11 / Camera pin 10 ¹⁾	
PA23	FS1	EXT1 pin 12 / Camera pin 9 ¹⁾	
PB28	SCK1	EXT1 pin 15	
PB29	MCK1	EXT1 pin 17	



Info:

1) Soldering is required to connect these pins to the camera connector. The resistor footprint *R205*, *R206*, *R207*, and *R208* have to be populated by 0-ohm resistors. The location of the footprints can be found in the [Kit Modifications](#) chapter.



Info: The I²S module can use more pins than listed in the table above. These signals are not listed in the table as they are shared with the on-board QSPI Flash and CAN transceiver.

Related Links

[Kit Modifications](#)

5.4 Embedded Debugger Implementation

SAM E54 Xplained Pro contain an Embedded Debugger (EDBG) that can be used to program and debug the ATSAME54P20A using Serial Wire Debug (SWD). The Embedded Debugger also includes a Virtual Com port interface over UART, a Data Gateway Interface over SPI, and I²C, and it includes four of the SAM E54 GPIOs. The kit also includes an XAM extension processor to the Embedded Debugger for on-board current measurement. Atmel Studio can be used as a front end for the Embedded Debugger.

5.4.1 Serial Wire Debug

The Serial Wire Debug (SWD) uses two pins to communicate with the target. For further information on how to use the programming and debugging capabilities of the EDBG, see [Embedded Debugger](#).

Table 5-24. SWD Connections

SAM E54 pin	Function	Shared functionality
PA30	SWCLK clock	Cortex DBG and TRACE
PA31	SWDIO data	Cortex DBG and TRACE
PB30	SWO output	Cortex DBG and TRACE
RESET_N	RESET	Cortex DBG , TRACE , and RST BTN

5.4.2 Virtual COM Port

The Embedded Debugger acts as a Virtual Com Port gateway by using one of the ATSAME54P20A UARTs. For further information on how to use the Virtual COM port, see [Embedded Debugger](#).

Table 5-25. Virtual COM Port Connections

SAM E54 pin	Function	Shared functionality
PB24	SERCOM2 PAD[1] UART RXD (SAM E54 RX line)	-
PB25	SERCOM2 PAD[0] UART TXD (SAM E54 TX line)	-

5.4.3 Data Gateway Interface

The Embedded Debugger features a Data Gateway Interface (DGI) by using either an SPI or I²C. The DGI can be used to send a variety of data from the ATSAME54P20A to the host PC. For further information on how to use the DGI interface, see [Data Visualizer](#) and the [EDBG User Guide](#).

Table 5-26. DGI Interface Connections when using SPI

SAM E54 pin	Function	Shared functionality
PD01	GPIO SPI SS (Slave select) (SAM E54 is Master)	-
PC04	SERCOM6 PAD[0] SPI MOSI (Master Out, Slave in)	EXT2 and EXT3
PC07	SERCOM6 PAD[3] SPI MISO (Master In, Slave Out)	EXT2 and EXT3
PC05	SERCOM6 PAD[1] SPI SCK (Clock Out)	EXT2 and EXT3

Table 5-27. DGI Interface Connections when using I²C

SAM E54 pin	Function	Shared functionality
PD08	SERCOM7 PAD[0] SDA (Data line)	AT24MAC402 , ATECC508 , PCC , EXT2 , and EXT3
PD09	SERCOM7 PAD[1] SCL (Clock line)	AT24MAC402 , ATECC508 , PCC , EXT2 , and EXT3

Four GPIO lines are connected to the Embedded Debugger. The EDBG can monitor these lines and time stamp pin value changes. This makes it possible to accurately time stamp events in the SAM E54 application code. For further information on how to configure and use the GPIO monitoring features, see [Data Visualizer](#) and the [EDBG User Guide](#).

Table 5-28. GPIO Lines Connected to the EDBG

SAM E54 pin	Function	Shared functionality
PC16	GPIO0	PDEC
PC17	GPIO1	PDEC
PC18	GPIO2	PDEC and User LED
PB31	GPIO3	User SW0

5.4.4 XAM Configuration

On the SAM E54 Xplained Pro the MCU and the MCU peripherals (e.g. extensions) are powered by its own regulator as shown in the figure below. All other parts of the board, mainly embedded debugger and accompanying Xplained Pro Analog Module (XAM), are powered from a separate regulator. The current to the MCU and peripherals can be measured by connecting them to the XAM output through jumper settings.

Figure 5-3. SAM E54 Xplained Pro XAM Implementation Block Diagram

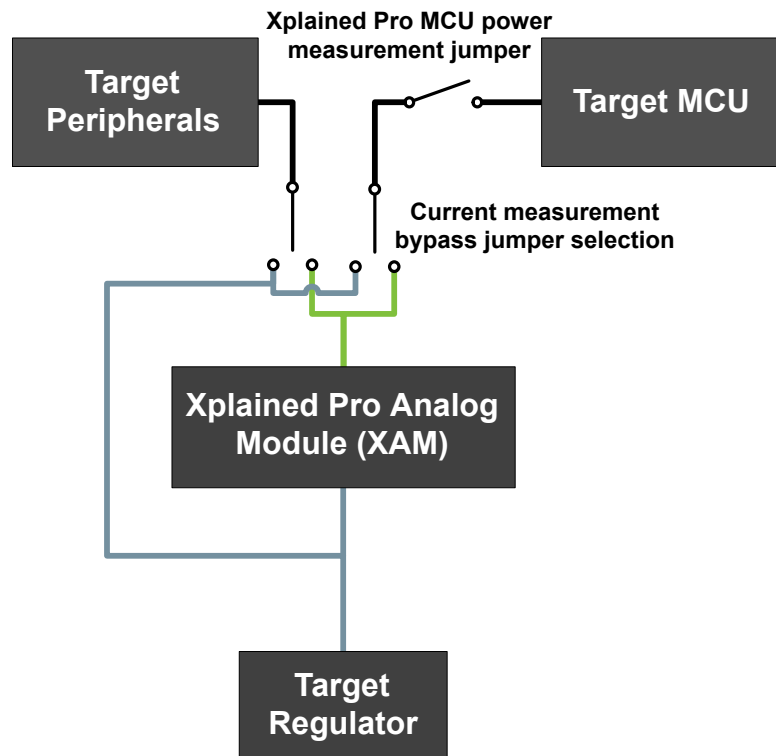

On the SAM E54 Xplained Pro the XAM can be used in four configurations:

1. **No current measurement or external MCU current measurement:** The XAM is bypassed and thus the MCU and peripherals are supplied directly by the regulator. Set both jumpers in the "BYPASS" position. In this configuration it is also possible to connect external measurement tools on the Xplained Pro MCU power measurement header to measure MCU current directly instead of using the XAM.
2. **MCU current measurement:** The XAM measures only the MCU current while the peripherals are supplied directly by the regulator. For this configuration place the jumper for "I/O" (peripherals) into the "BYPASS" position and the "MCU" into the "MEASURE" position.
3. **Peripherals measurement:** The XAM measures only the peripherals current while the MCU is directly supplied by the regulator. For this configuration place the jumper for "MCU" into the "BYPASS" position and the "I/O" jumper into the "MEASURE" position.
4. **MCU and peripherals measurement:** In this configuration both the MCU and peripherals are measured by the XAM. Place both jumpers on "I/O" and "MCU" headers in the "MEASURE" position.

5.5 Kit Modifications

SAM E54 Xplained Pro has several resistors that can be used to disconnect I/O pins of the ATSAME54P20A from connectors and on-board ICs, and to disconnect power signals.



Info: Note that there are some resistors that aren't mounted by default on the kit listed in the table below.

Table 5-29. Resistors

Designator	Value	From	To	Comment
J101	cut-strap	VCC_P3V3	VCC_P3V3_CM_IN	ATSAME54P20A, peripherals and connectors power supply
R101	0Ω	U100 OUT	VCC_CM_P3V3	XAM power supply
R103	0Ω	U100 OUT	VCC_EDBG_P3V3	EDBG power supply
R205	0Ω [N.M.]	J406 PCC DATA04	PA20 SDHC CMD	Allows complete or partial disconnect of header J406, Parallel Capture Controller, header from ATSAME54P20A, and shared signals. Remove the mounted resistors and mount the unmounted resistors if using the PCC header.
R206	0Ω [N.M.]	J406 PCC DATA05	PA21 SHDC CK	
R207	0Ω [N.M.]	J406 PCC DATA06	PA22 I ² C HS SDA	
R208	0Ω [N.M.]	J406 PCC DATA07	PA23 I ² C HS SCL	
R308	10kΩ	PCC DATA0	QTouch Button	
R621	0Ω	PA17 ETH GTXEN	PHY_TXEN	
R622	0Ω	PA18 ETH GTX0	PHY_TXD0	
R623	0Ω	PA19 ETH GTX1	PHY_TXD1	
R624	0Ω	PA13 ETH GRX0	PHY_RXD0	
R625	0Ω	PA12 ETH GRX1	PHY_RXD1	
R626	0Ω	PA15 ETH GRXER	PHY_RXER	
R628	0Ω	PC12 ETH GMDIO	PHY_MDIO	
R629	0Ω	PC11 ETH GMDC	PHY_MDC	
R630	0Ω	PA14 ETH GTXCK	PHY_REFCLK	
R609	4.7kΩ [N.M.]	PHYAD	VCC_TARGET_P3V3	Configuration for default start-up conditions for the Ethernet PHY.
R616	1kΩ	PHYAD	GND	
R613	4.7kΩ [N.M.]	PME_EN	VCC_TARGET_P3V3	
R618	1kΩ [N.M.]	PME_EN	GND	
R605	4.7kΩ	ANEN_SPEED	VCC_TARGET_P3V3	
R619	1kΩ	ANEN_SPEED	GND	
R802	39Ω	EDBG TARGET RESET	TARGET MCU RESET	Debug interface from the EDBG to the ATSAME54P20A
R803	0Ω	EDBG SWCLK	PA30 SWCLK	

Designator	Value	From	To	Comment
R824	0Ω	EDBG SWDIO	PA31 SWDIO	EDBG CDC and DGI interfaces to the ATSAME54P20A
R827	0Ω	EDBG SWO	PB30 SWO	
R808	0Ω	EDBG CDC RX	PB25 UART TX	
R809	330Ω	EDBG CDC TX	PB24 UART RX	
R810	330Ω	EDBG DGI_GPIO0	PC16 GPIO	
R811	330Ω	EDBG DGI_GPIO1	PC17 GPIO	
R813	0Ω	EDBG I ² C SDA	PD08 I ² C SDA	
R814	0Ω	EDBG I ² C SCL	PD09 I ² C SCL	
R815	330Ω	EDBG SPI MISO	PC07 SPI MISO	
R816	0Ω	EDBG SPI MOSI	PC04 SPI MOSI	
R817	0Ω	EDBG SPI SCK	PC05 SPI SCK	
R818	0Ω	EDBG SS	PD01 SPI SS	
R825	330Ω	EDBG DGI_GPIO2	PC18 GPIO	
R826	330Ω	EDBG DGI_GPIO3	PB31 GPIO	
R812	0Ω	TARGET RESET SENSE	TARGET_MCU_RESET	

Figure 5-4. Assembly Drawing Top

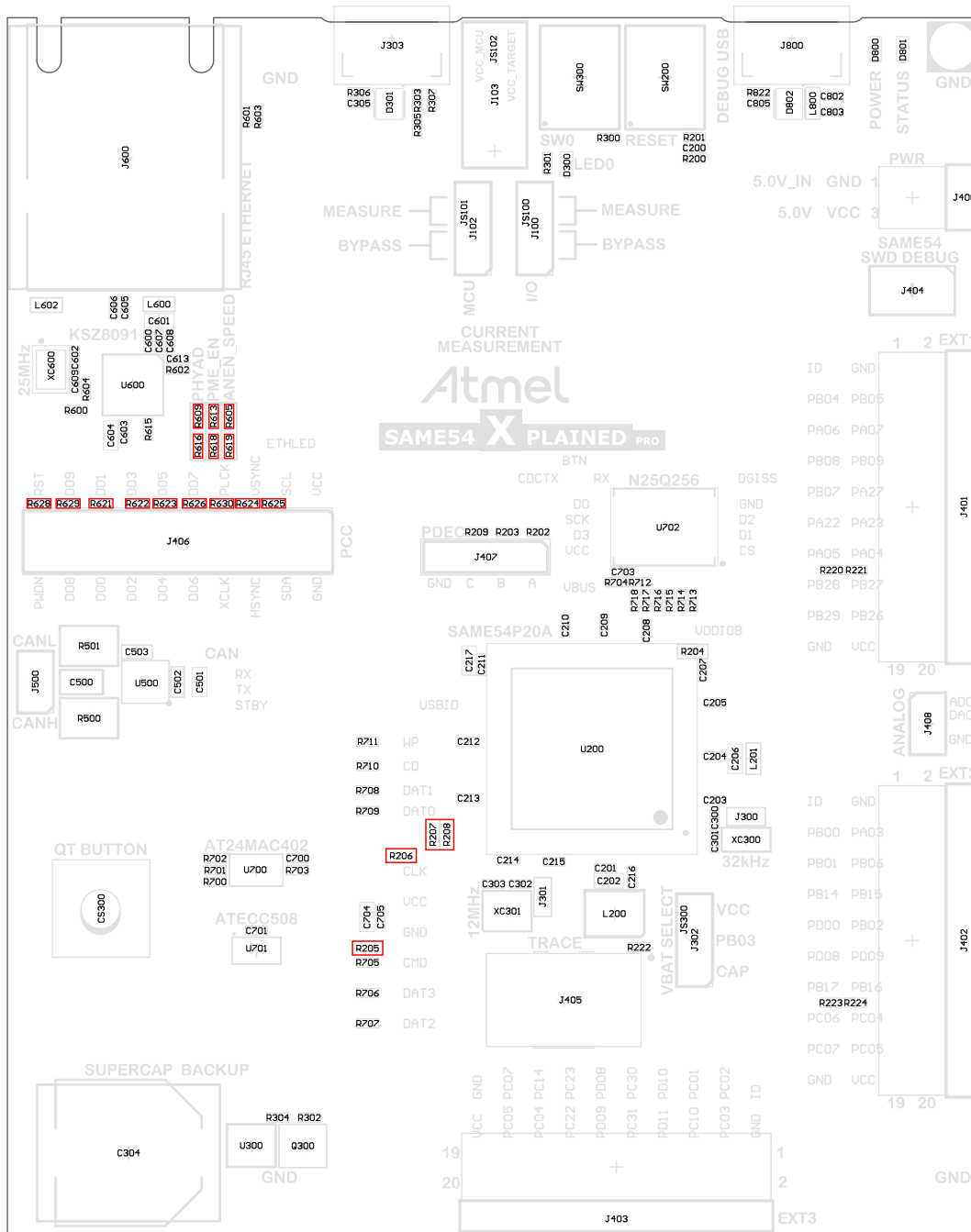
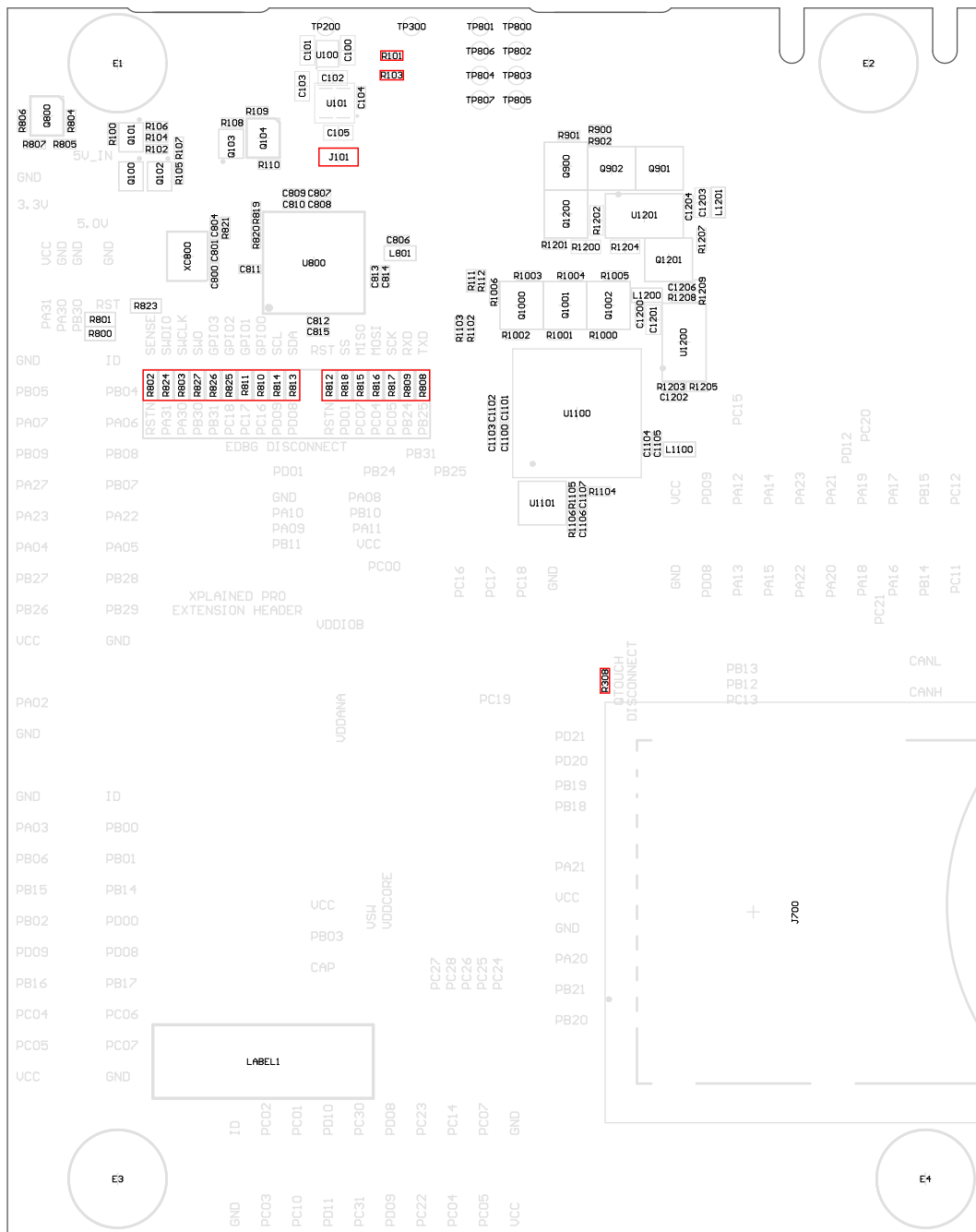

Figure 5-5. Assembly Drawing Bottom



5.5.1 Enable PCC Header

The PCC header on the SAM E54 Xplained Pro board is by default not functional due to shared connections with Ethernet, QTouch, SD Card, EXT1, and EXT2.

To modify the kit to fully enable the PCC header, do the following:

- Remove the resistors: R621, R622, R623, R624, R625, R626, R628, R629, R630 to separate the Ethernet PHY from the lines
- Mount 0Ω resistors: R205, R206, R207, R208

- Optionally remove: R308 (There is no contention here, but can represent a large load on the signal.)
- Remove any SD/SDIO cards from the SD Card connector



caution: PCC will not work at the same time as Ethernet, SD Card, QTouch, and I²C on EXT1.



Info: Revert the steps to restore the original functionality. Use 0Ω resistors or solder blobs to short strap.

5.5.2 Operation at Other Voltages

The SAM E54 Xplained Pro board is operated at 3.3V by default, but it also has the possibility of running at lower voltages from an external supply. The EDBG is designed to run from a 3.3V supply and won't work on other voltages, therefore all connections from the EDBG and the on board 3.3V regulator to the ATSAME54P20A have to be removed.

To completely disconnect the EDBG and the on-board power supply from the ATSAME54P20A do the following:

- Remove the two jumpers from the on-board 3-pin current measurement headers (J100 and J102), and connect the two center pins (pin 2) together with a wire or an ammeter, as shown in [Figure 5-7](#)
- Remove R802, R803, R808, R809, R810, R811, R812, R813, R814, R815, R816, R817, R818, R824, R825, R826, R827
- Optionally cut J101 to remove power to the on-board current measurement headers (J100 and J102) from the on-board regulator

[Figure 5-6](#) shows all components that have to be removed from the bottom side of the PCB for operation at other voltages. To locate the other components, see the assembly drawing in the section above. When the components are removed, the kit can be supplied with a desired voltage through the pins marked 3.3V (pin four) and GND (pin two) on the Xplained Pro power header. To program and debug the ATSAME54P20A the 2x5 50mil Cortex debug connector has to be used with an external debugger.



Info: Operating the ATSAME54P20A on other voltages than 3.3V requires physical modifications on the kit using a soldering iron and an external debugger for programming the ATSAME54P20A. The on-board current measurement only works at 3.3V. The on-board LED is selected for 3.3V operation, the light level at 1.8V operation is very low. To increase the emitted light level the value of the series resistor can be lowered. The EDBG functionality can be restored by re-soldering the removed components and soldering a 0Ω resistor over J101.



Caution: The voltage supplied through the power header is applied directly to the ATSAME54P20A and the extension headers. Applying a voltage greater than 3.3V may damage the board permanently.

Figure 5-6. SAM E54 Xplained Pro EDBG Disconnect

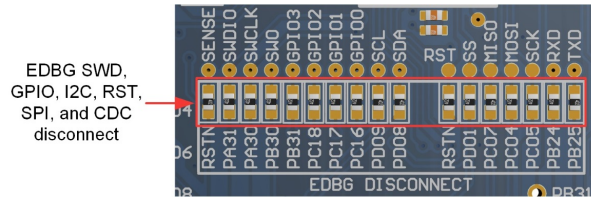
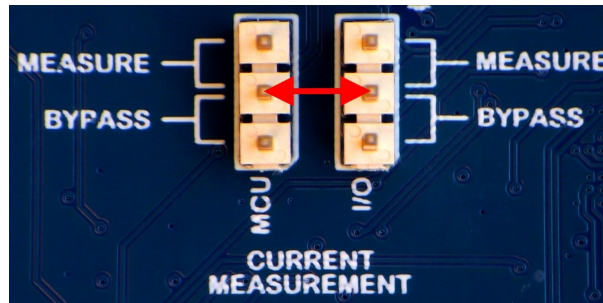

Figure 5-7. SAM E54 Xplained Pro Current Measurement Headers



Related Links

- [Xplained Pro Power Header](#)
- [Cortex Debug Connector Connectors](#)

5.6 Low-Power Mode

Acquiring the lowest power consumption of the device requires some specific settings of the GPIOs in relation to the connected peripherals. The table below describes the settings needed for the lowest possible power consumption. If not otherwise noted, all pins should disable all digital logic ($DIR = 0$, $INEN = 0$ and $PULLEN = 0$).



Info: The power consumption on the microcontrollers VDD will be higher than specified in the electrical characteristics of the device due to connected peripherals.

Table 5-30. Low Power Settings

SAM E54 pin	Signal	State	Description
PC21	ETH RESET	Output low	The on-board Ethernet PHY KSZ8091 continuously generates a 50 MHz clock signal to PA14 on the SAM E54. When the KSZ8091 is in reset the clock signal is not generated and the power consumption of the SAM E54 is reduced.

6. Kit Specific Data

One of the Flash user pages in the EDBG is programmed with data specific to the SAM E54 Xplained Pro. The data can be read through the I²C interface connected to the EDBG from the target application. For detailed information, refer to the [EDBG User Guide](#). All data is stored as little endian. The table below shows the memory map for the Flash user page.

Table 6-1. MAC48Register, Offset: 0x00

Name	Description	Size [bits]
MAC48	Unique address assigned to the kit, value taken from the onboard AT24MAC402.	48

7. Appendix

7.1 Getting Started with IAR

IAR Embedded Workbench® for ARM® is a proprietary, high-efficiency compiler not based on GCC. The programming and debugging of Xplained Pro kits are supported in IAR™ Embedded Workbench for ARM using the common CMSIS-DAP interface. Some initial settings have to be set up in the project to get programming and debugging to work.

The following steps explain how to set up a project for programming and debugging:

1. Open the project that needs to be configured. Open the **OPTIONS** dialog for the project.
2. In the **General Options** category, select the **Target** tab. [Select the "Device" for the project or the "Core" of the device.](#)
3. In the **Debugger** category, select the **Setup** tab. [Select CMSIS DAP as the driver.](#)
4. In the **Debugger** category, select the **Download** tab. [Select the Use flash loader\(s\) option.](#)
5. In the **Debugger > CMSIS DAP** category, select the **Setup** tab. [Select System \(default\) as the reset method.](#)
6. In the category **Debugger > CMSIS DAP**, select the **JTAG/SWD** tab. [Select SWD as the interface and optionally select the SWD speed.](#)

Figure 7-1. Select Target Device

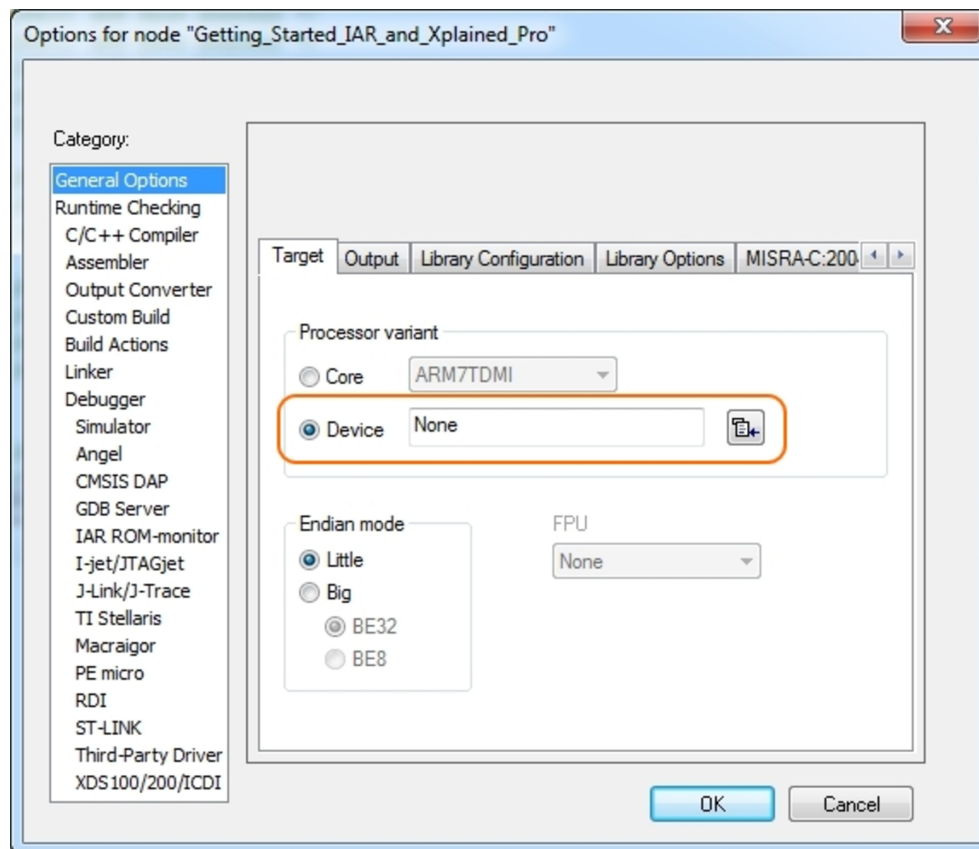

Figure 7-2. Select Debugger

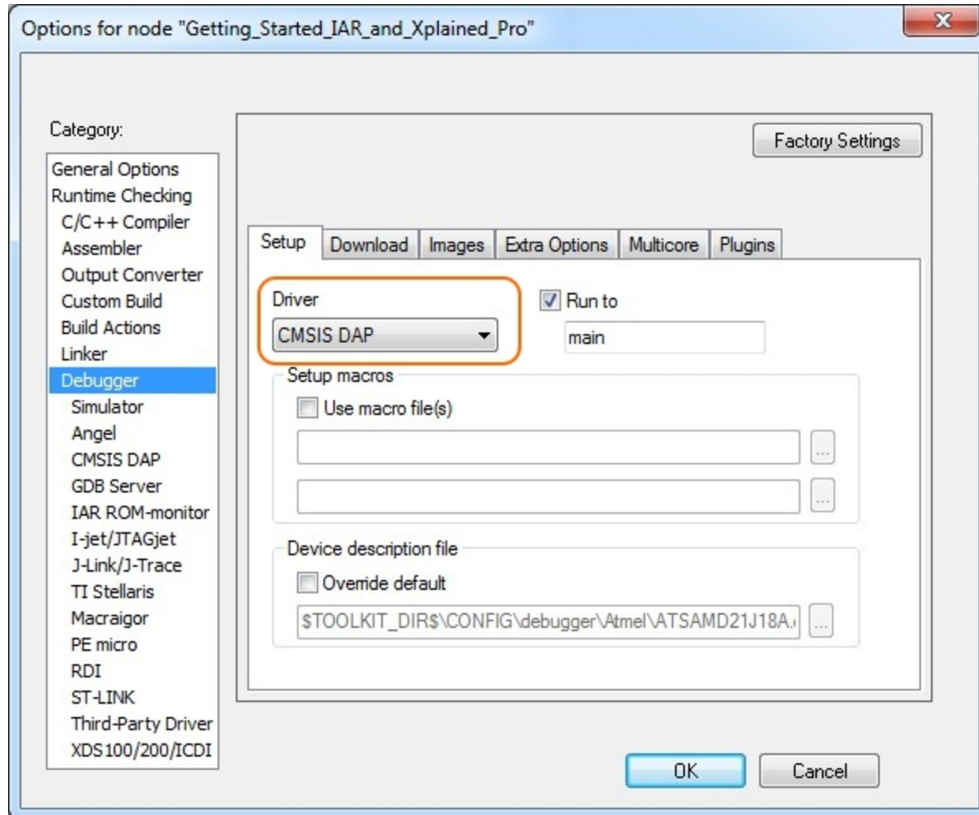

Figure 7-3. Configure Flash Loader

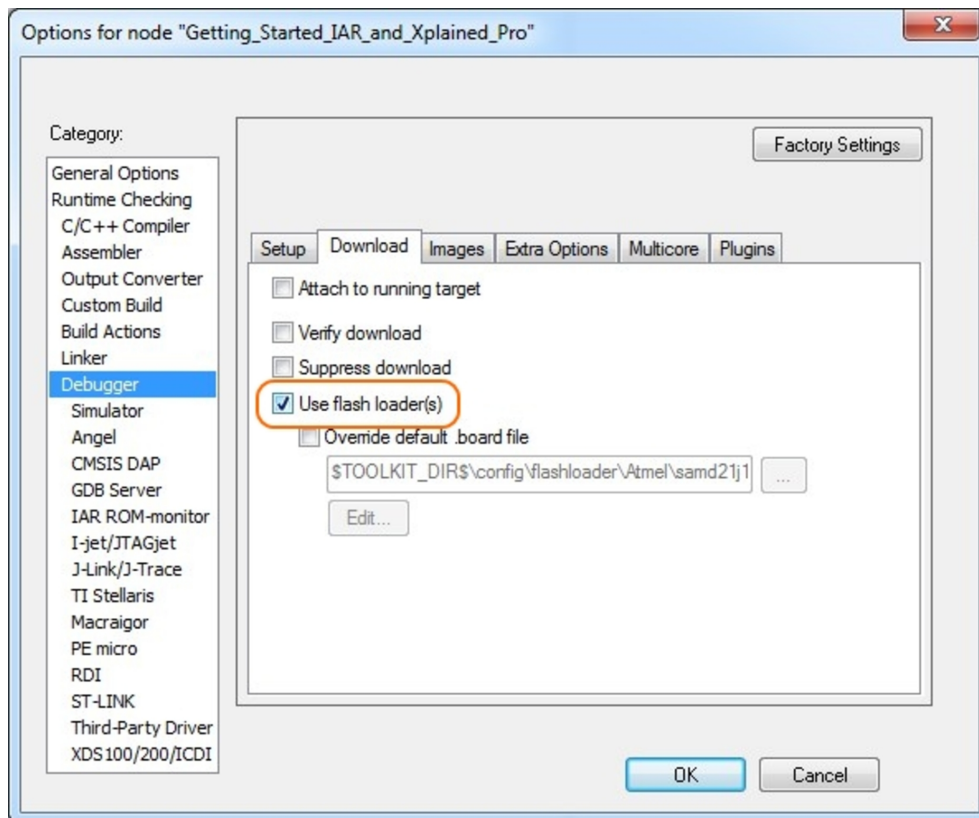

Figure 7-4. Configure Reset

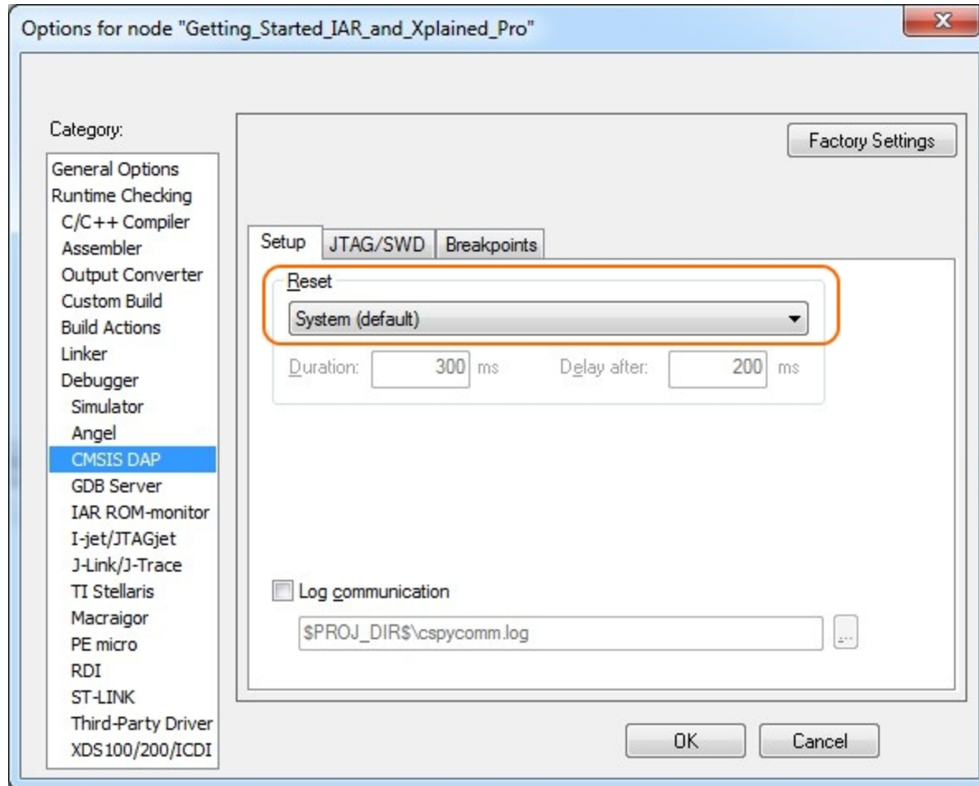
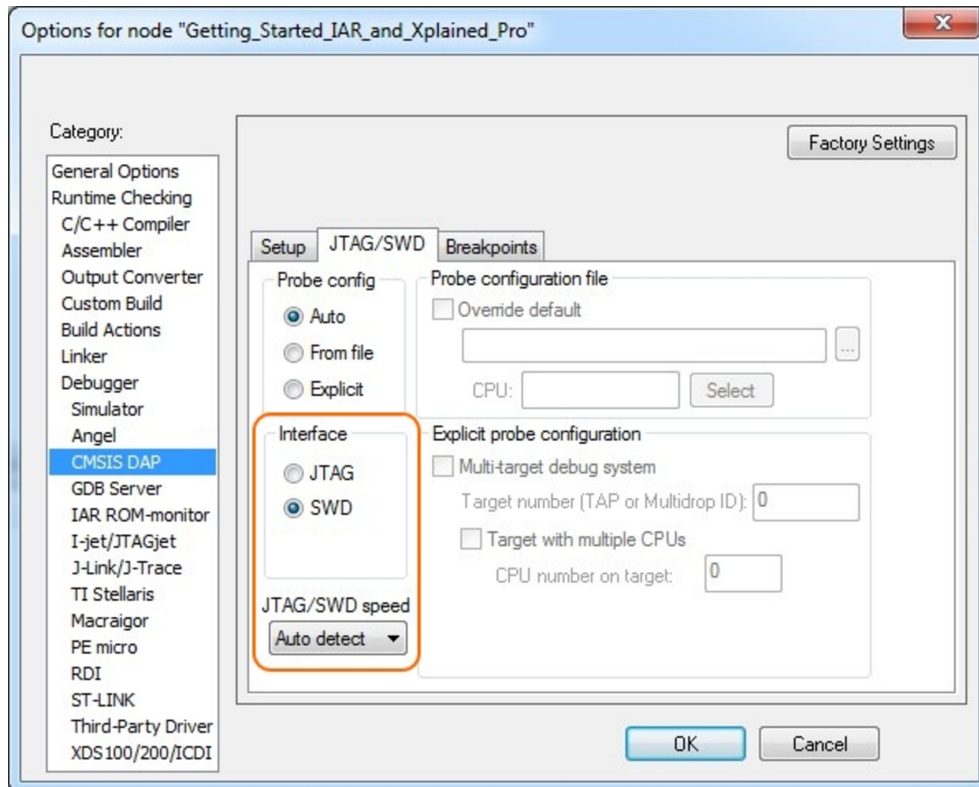

Figure 7-5. Configure Interface



7.2 Connecting External Debuggers to an Xplained Pro Board

The Xplained Pro kits that features a 10-pin 50mil debug connector can use external debug tools like SAM-ICE™ or Atmel-ICE instead of the built-in EDBG. Evaluation kits with devices using the SWD interface on-board has a connector that is pinout compatible with the [Cortex Debug Connector](#).

The SAM-ICE is connected to the debug connector on an Xplained Pro using either an Atmel-ICE adapter, SAM-ICE adapter, or a 10-pin 50-mil header to squid cable. When using a squid cable, see the table and figures below for how to connect the SAM-ICE to the Xplained Pro board.

Table 7-1. Squid Cable Connections

Squid Cable Pin	SAM-ICE Pin
1 (VCC)	1 (VTref)
2 (SWDIO/TMS)	7 (TMS)
3 (GND)	4 (GND)
4 (SWCLK/TCK)	9 (TCK)
5 (GND)	6 (GND)
6 (SWO/TDO)	13 (TDO) ⁽¹⁾
7 (Not used)	
8 (Not used)	
9 (Not used)	
10 (RESET)	15 (RESET)

Note:

1. Optional pin; used only when the device functionality supports TDO.

Figure 7-6. SAM-ICE using a Squid Cable



Figure 7-7. SAM-ICE using an Atmel-ICE Adapter



Important:

If contention with the on-board EDBG occurs, power the Xplained Pro board from another input like the external power header or from the target USB. Physically removing the connection between the EDBG and the debug header by removing 0Ω resistors, where available, or cutting the tracks to the EDBG can also be done.

8. Hardware Revision History and Known Issues

This user guide is written to reflect the latest available revision of the kit. This chapter contains information about known issues, a revision history of older revisions, and how older revisions differ from the latest revision.

8.1 Identifying Product ID and Revision

The revision and product identifier of the Xplained Pro boards can be found in two ways: either through Atmel Studio or by looking at the sticker on the bottom side of the PCB.

When an Xplained Pro MCU board is connected to a computer with Atmel Studio running, an information window with the serial number is shown. The first six digits of the serial number contain the product identifier and revision. Information about connected Xplained Pro extension boards is also shown in the window.

The same information can be found on the sticker on the bottom side of the PCB. Most kits have stickers that have the identifier and revision printed in plain text as A09-nnnn\rr, where nnnn is the identifier and rr is the revision. Boards with limited space have a sticker with only a data matrix code, which contains a serial number string.

The serial number string has the following format:

```
"nnnnrrssssssss"  
n = product identifier  
r = revision  
s = serial number
```

The product identifier for the SAM E54 Xplained Pro is A09-2748.

8.2 Revision 5

Device revision A0 of ATSAME54P20A is mounted on revision 5 of SAM E54 Xplained Pro.

8.2.1 VBAT Pin

There is an issue with the VBAT pin in ATSAME54P20A revision A0. When VBAT > VDDIO there is a current over-consumption rendering the on-board super-capacitor backup solution unusable.

8.3 Revision 4

Revision 4 is the initially released revision.

The Early Adopter version of ATSAME54P20A is mounted on revision 4 of SAM E54 Xplained Pro.

8.3.1 VBAT Pin

There is an issue with the VBAT pin in ATSAME54P20A revision A0. When VBAT > VDDIO there is a current over-consumption rendering the on-board super-capacitor backup solution unusable.

8.3.2 32.768 KHz Crystal

The 32.768 KHz crystal mounted on revision 4 of SAM E54 Xplained Pro is a Kyocera Crystal Device Corporation ST3215SB32768E0HPWBB 9 pF crystal. The external matching capacitors C300 and C301 are 15 pF. The crystal is matched to be driven by the SAM E54 in standard mode.



Info: Using a crystal with lower capacitive load will reduce the required drive level to keep the crystal oscillation. Revision 5 of SAM E54 Xplained Pro replaced the 32.768kHz crystal with the 5 pF version ST3215SB32768A0HPWBB to reduce the drive level from 62nW to 15nW.

9. Document Revision History

Date	Comment
07/2017	Initial document release.

The Microchip Web Site

Microchip provides online support via our web site at <http://www.microchip.com/>. This web site is used as a means to make files and information easily available to customers. Accessible by using your favorite Internet browser, the web site contains the following information:

- **Product Support** – Data sheets and errata, application notes and sample programs, design resources, user's guides and hardware support documents, latest software releases and archived software
- **General Technical Support** – Frequently Asked Questions (FAQ), technical support requests, online discussion groups, Microchip consultant program member listing
- **Business of Microchip** – Product selector and ordering guides, latest Microchip press releases, listing of seminars and events, listings of Microchip sales offices, distributors and factory representatives

Customer Change Notification Service

Microchip's customer notification service helps keep customers current on Microchip products. Subscribers will receive e-mail notification whenever there are changes, updates, revisions or errata related to a specified product family or development tool of interest.

To register, access the Microchip web site at <http://www.microchip.com/>. Under "Support", click on "Customer Change Notification" and follow the registration instructions.

Customer Support

Users of Microchip products can receive assistance through several channels:

- Distributor or Representative
- Local Sales Office
- Field Application Engineer (FAE)
- Technical Support

Customers should contact their distributor, representative or Field Application Engineer (FAE) for support. Local sales offices are also available to help customers. A listing of sales offices and locations is included in the back of this document.

Technical support is available through the web site at: <http://www.microchip.com/support>

Microchip Devices Code Protection Feature

Note the following details of the code protection feature on Microchip devices:

- Microchip products meet the specification contained in their particular Microchip Data Sheet.
- Microchip believes that its family of products is one of the most secure families of its kind on the market today, when used in the intended manner and under normal conditions.
- There are dishonest and possibly illegal methods used to breach the code protection feature. All of these methods, to our knowledge, require using the Microchip products in a manner outside the operating specifications contained in Microchip's Data Sheets. Most likely, the person doing so is engaged in theft of intellectual property.
- Microchip is willing to work with the customer who is concerned about the integrity of their code.

- Neither Microchip nor any other semiconductor manufacturer can guarantee the security of their code. Code protection does not mean that we are guaranteeing the product as “unbreakable.”

Code protection is constantly evolving. We at Microchip are committed to continuously improving the code protection features of our products. Attempts to break Microchip’s code protection feature may be a violation of the Digital Millennium Copyright Act. If such acts allow unauthorized access to your software or other copyrighted work, you may have a right to sue for relief under that Act.

Legal Notice

Information contained in this publication regarding device applications and the like is provided only for your convenience and may be superseded by updates. It is your responsibility to ensure that your application meets with your specifications. MICROCHIP MAKES NO REPRESENTATIONS OR WARRANTIES OF ANY KIND WHETHER EXPRESS OR IMPLIED, WRITTEN OR ORAL, STATUTORY OR OTHERWISE, RELATED TO THE INFORMATION, INCLUDING BUT NOT LIMITED TO ITS CONDITION, QUALITY, PERFORMANCE, MERCHANTABILITY OR FITNESS FOR PURPOSE. Microchip disclaims all liability arising from this information and its use. Use of Microchip devices in life support and/or safety applications is entirely at the buyer’s risk, and the buyer agrees to defend, indemnify and hold harmless Microchip from any and all damages, claims, suits, or expenses resulting from such use. No licenses are conveyed, implicitly or otherwise, under any Microchip intellectual property rights unless otherwise stated.

Trademarks

The Microchip name and logo, the Microchip logo, AnyRate, AVR, AVR logo, AVR Freaks, BeaconThings, BitCloud, CryptoMemory, CryptoRF, dsPIC, FlashFlex, flexPWR, Heldo, JukeBlox, KeeLoq, KeeLoq logo, Klear, LANCheck, LINK MD, maXStylus, maXTouch, MediaLB, megaAVR, MOST, MOST logo, MPLAB, OptoLyzer, PIC, picoPower, PICSTART, PIC32 logo, Prochip Designer, QTouch, RightTouch, SAM-BA, SpyNIC, SST, SST Logo, SuperFlash, tinyAVR, UNI/O, and XMEGA are registered trademarks of Microchip Technology Incorporated in the U.S.A. and other countries.

ClockWorks, The Embedded Control Solutions Company, EtherSynch, Hyper Speed Control, HyperLight Load, IntelliMOS, mTouch, Precision Edge, and Quiet-Wire are registered trademarks of Microchip Technology Incorporated in the U.S.A.

Adjacent Key Suppression, AKS, Analog-for-the-Digital Age, Any Capacitor, AnyIn, AnyOut, BodyCom, chipKIT, chipKIT logo, CodeGuard, CryptoAuthentication, CryptoCompanion, CryptoController, dsPICDEM, dsPICDEM.net, Dynamic Average Matching, DAM, ECAN, EtherGREEN, In-Circuit Serial Programming, ICSP, Inter-Chip Connectivity, JitterBlocker, KlearNet, KlearNet logo, Mindi, MiWi, motorBench, MPASM, MPF, MPLAB Certified logo, MPLIB, MPLINK, MultiTRAK, NetDetach, Omniscient Code Generation, PICDEM, PICDEM.net, PICKit, PICTail, PureSilicon, QMatrix, RightTouch logo, REAL ICE, Ripple Blocker, SAM-ICE, Serial Quad I/O, SMART-I.S., SQI, SuperSwitcher, SuperSwitcher II, Total Endurance, TSHARC, USBCheck, VariSense, ViewSpan, WiperLock, Wireless DNA, and ZENA are trademarks of Microchip Technology Incorporated in the U.S.A. and other countries.

SQTP is a service mark of Microchip Technology Incorporated in the U.S.A.

Silicon Storage Technology is a registered trademark of Microchip Technology Inc. in other countries.

GestIC is a registered trademark of Microchip Technology Germany II GmbH & Co. KG, a subsidiary of Microchip Technology Inc., in other countries.

All other trademarks mentioned herein are property of their respective companies.

© 2017, Microchip Technology Incorporated, Printed in the U.S.A., All Rights Reserved.

ISBN: 978-1-5224-1929-7

Quality Management System Certified by DNV

ISO/TS 16949

Microchip received ISO/TS-16949:2009 certification for its worldwide headquarters, design and wafer fabrication facilities in Chandler and Tempe, Arizona; Gresham, Oregon and design centers in California and India. The Company's quality system processes and procedures are for its PIC[®] MCUs and dsPIC[®] DSCs, KEELOQ[®] code hopping devices, Serial EEPROMs, microperipherals, nonvolatile memory and analog products. In addition, Microchip's quality system for the design and manufacture of development systems is ISO 9001:2000 certified.

Worldwide Sales and Service

AMERICAS	ASIA/PACIFIC	ASIA/PACIFIC	EUROPE
<p>Corporate Office 2355 West Chandler Blvd. Chandler, AZ 85224-6199 Tel: 480-792-7200 Fax: 480-792-7277 Technical Support: http://www.microchip.com/support Web Address: www.microchip.com</p> <p>Atlanta Duluth, GA Tel: 678-957-9614 Fax: 678-957-1455</p> <p>Austin, TX Tel: 512-257-3370</p> <p>Boston Westborough, MA Tel: 774-760-0087 Fax: 774-760-0088</p> <p>Chicago Itasca, IL Tel: 630-285-0071 Fax: 630-285-0075</p> <p>Dallas Addison, TX Tel: 972-818-7423 Fax: 972-818-2924</p> <p>Detroit Novi, MI Tel: 248-848-4000</p> <p>Houston, TX Tel: 281-894-5983</p> <p>Indianapolis Noblesville, IN Tel: 317-773-8323 Fax: 317-773-5453 Tel: 317-536-2380</p> <p>Los Angeles Mission Viejo, CA Tel: 949-462-9523 Fax: 949-462-9608 Tel: 951-273-7800</p> <p>Raleigh, NC Tel: 919-844-7510</p> <p>New York, NY Tel: 631-435-6000</p> <p>San Jose, CA Tel: 408-735-9110 Tel: 408-436-4270</p> <p>Canada - Toronto Tel: 905-695-1980 Fax: 905-695-2078</p>	<p>Asia Pacific Office Suites 3707-14, 37th Floor Tower 6, The Gateway Harbour City, Kowloon</p> <p>Hong Kong Tel: 852-2943-5100 Fax: 852-2401-3431</p> <p>Australia - Sydney Tel: 61-2-9868-6733 Fax: 61-2-9868-6755</p> <p>China - Beijing Tel: 86-10-8569-7000 Fax: 86-10-8528-2104</p> <p>China - Chengdu Tel: 86-28-8665-5511 Fax: 86-28-8665-7889</p> <p>China - Chongqing Tel: 86-23-8980-9588 Fax: 86-23-8980-9500</p> <p>China - Dongguan Tel: 86-769-8702-9880</p> <p>China - Guangzhou Tel: 86-20-8755-8029</p> <p>China - Hangzhou Tel: 86-571-8792-8115 Fax: 86-571-8792-8116</p> <p>China - Hong Kong SAR Tel: 852-2943-5100 Fax: 852-2401-3431</p> <p>China - Nanjing Tel: 86-25-8473-2460 Fax: 86-25-8473-2470</p> <p>China - Qingdao Tel: 86-532-8502-7355 Fax: 86-532-8502-7205</p> <p>China - Shanghai Tel: 86-21-3326-8000 Fax: 86-21-3326-8021</p> <p>China - Shenyang Tel: 86-24-2334-2829 Fax: 86-24-2334-2393</p> <p>China - Shenzhen Tel: 86-755-8864-2200 Fax: 86-755-8203-1760</p> <p>China - Wuhan Tel: 86-27-5980-5300 Fax: 86-27-5980-5118</p> <p>China - Xian Tel: 86-29-8833-7252 Fax: 86-29-8833-7256</p>	<p>China - Xiamen Tel: 86-592-2388138 Fax: 86-592-2388130</p> <p>China - Zhuhai Tel: 86-756-3210040 Fax: 86-756-3210049</p> <p>India - Bangalore Tel: 91-80-3090-4444 Fax: 91-80-3090-4123</p> <p>India - New Delhi Tel: 91-11-4160-8631 Fax: 91-11-4160-8632</p> <p>India - Pune Tel: 91-20-3019-1500</p> <p>Japan - Osaka Tel: 81-6-6152-7160 Fax: 81-6-6152-9310</p> <p>Japan - Tokyo Tel: 81-3-6880-3770 Fax: 81-3-6880-3771</p> <p>Korea - Daegu Tel: 82-53-744-4301 Fax: 82-53-744-4302</p> <p>Korea - Seoul Tel: 82-2-554-7200 Fax: 82-2-558-5932 or 82-2-558-5934</p> <p>Malaysia - Kuala Lumpur Tel: 60-3-6201-9857 Fax: 60-3-6201-9859</p> <p>Malaysia - Penang Tel: 60-4-227-8870 Fax: 60-4-227-4068</p> <p>Philippines - Manila Tel: 63-2-634-9065 Fax: 63-2-634-9069</p> <p>Singapore Tel: 65-6334-8870 Fax: 65-6334-8850</p> <p>Taiwan - Hsin Chu Tel: 886-3-5778-366 Fax: 886-3-5770-955</p> <p>Taiwan - Kaohsiung Tel: 886-7-213-7830</p> <p>Taiwan - Taipei Tel: 886-2-2508-8600 Fax: 886-2-2508-0102</p> <p>Thailand - Bangkok Tel: 66-2-694-1351 Fax: 66-2-694-1350</p>	<p>Austria - Wels Tel: 43-7242-2244-39 Fax: 43-7242-2244-393</p> <p>Denmark - Copenhagen Tel: 45-4450-2828 Fax: 45-4485-2829</p> <p>Finland - Espoo Tel: 358-9-4520-820</p> <p>France - Paris Tel: 33-1-69-53-63-20 Fax: 33-1-69-30-90-79</p> <p>France - Saint Cloud Tel: 33-1-30-60-70-00</p> <p>Germany - Garching Tel: 49-8931-9700</p> <p>Germany - Haan Tel: 49-2129-3766400</p> <p>Germany - Heilbronn Tel: 49-7131-67-3636</p> <p>Germany - Karlsruhe Tel: 49-721-625370</p> <p>Germany - Munich Tel: 49-89-627-144-0 Fax: 49-89-627-144-44</p> <p>Germany - Rosenheim Tel: 49-8031-354-560</p> <p>Israel - Ra'anana Tel: 972-9-744-7705</p> <p>Italy - Milan Tel: 39-0331-742611 Fax: 39-0331-466781</p> <p>Italy - Padova Tel: 39-049-7625286</p> <p>Netherlands - Druenen Tel: 31-416-690399 Fax: 31-416-690340</p> <p>Norway - Trondheim Tel: 47-7289-7561</p> <p>Poland - Warsaw Tel: 48-22-3325737</p> <p>Romania - Bucharest Tel: 40-21-407-87-50</p> <p>Spain - Madrid Tel: 34-91-708-08-90 Fax: 34-91-708-08-91</p> <p>Sweden - Gothenburg Tel: 46-31-704-60-40</p> <p>Sweden - Stockholm Tel: 46-8-5090-4654</p> <p>UK - Wokingham Tel: 44-118-921-5800 Fax: 44-118-921-5820</p>

Mouser Electronics

Authorized Distributor

Click to View Pricing, Inventory, Delivery & Lifecycle Information:

[Microchip:](#)

[ATSAME54-XPRO](#)